

# Компактный пневмоцилиндр низкого трения (уплотнение типа «металл по металлу»)

## MQQ

Предназначен для работы в условиях низкого давления, на малой и постоянной скорости. Уплотнение типа «металл по металлу» позволяет достичь рабочих параметров, недоступных обычным пневмоцилиндрам.

- Возможность работы на предельно низких давлениях (0.005 МПа)
- Равномерное движение на малых скоростях (0.3 мм/с)
- Длительный срок службы (ресурс свыше 100 млн. циклов)
- Низкое трение позволяет управлять усилиями с точностью до 0.05 Н.  
Временное бездействие оборудования не приводит к увеличению трения



### Технические характеристики

#### Стандартное исполнение - MQQT

Диаметр цилиндра (мм)		10	16	20	25	30
Уплотнение	Металл по металлу					
Принцип действия	Двустороннего действия/односторонний шток					
Среда	Очищенный сжатый воздух (0.3 мкм)					
Испытательное давление (МПа)	1.05					
Максимальное рабочее давление (МПа)	0.5					
Минимальное рабочее давление (МПа)	0.005					
Температура рабочей и окружающей среды (°C)	-10 ~ +80					
Демпфирование	Упругий демпфер (стандарт)					
Смазка	Не требуется					
Резьба поршневого штока	Внутренняя					
Допуск на длину хода	0/+1.0					
Скорость поршня (мм/с)	0.3 ~ 300					
Допустимые утечки (см <sup>3</sup> /мин) при давлении:	0.1 МПа	150	200		300	
	0.3 МПа	800	1000		1200	
	0.5 МПа	1500	2000		3000	

#### Исполнение с повышенным сопротивлением боковым нагрузкам - MQQL

Диаметр цилиндра (мм)		10	16	20	25	30
Уплотнение	Металл по металлу					
Принцип действия	Двустороннего действия/односторонний шток					
Среда	Очищенный сжатый воздух (0.3 мкм)					
Испытательное давление (МПа)	1.05					
Максимальное рабочее давление (МПа)	0.7					
Минимальное рабочее давление (МПа)	0.005					
Температура рабочей и окружающей среды (°C)	-10 ~ +80					
Демпфирование	Упругий демпфер (стандарт)					
Смазка	Не требуется					
Резьба поршневого штока	Внутренняя					
Допуск на длину хода	0/+1.0					
Скорость поршня (мм/с)	0.5 ~ 500					
Допустимые утечки (см <sup>3</sup> /мин) при давлении:	0.1 МПа	150	200		300	
	0.3 МПа	800	1000		1200	
	0.5 МПа	1500	2000		3000	

# Low Friction Cylinders

## Series MQ

### Metal Seal Type

#### Compact Low Friction Cylinder Series MQQ

P.1172



Series	Bore size (mm)	Operating pressure range (MPa)	Actuation speed (mm/s)
<b>MQQT</b> Standard type	10	0.005 to 0.5	0.3 to 300
	16		
	20		
<b>MQQL</b> Lateral load resisting type (Built-in ball bushing)	25	0.005 to 0.7	0.5 to 500
	30		
	30		
	40		

#### Lateral Load Resisting Low Friction Cylinder Series MQM

P.1181



Series	Bore size (mm)	Operating pressure range (MPa)	Actuation speed (mm/s)
<b>MQML</b> Standard type	6 (Standard only)	ø6: 0.02 to 0.7 ø10 to ø25: 0.005 to 0.7	0.5 to 1000
	10		
	16		
<b>MQML</b> □ □ H High speed/frequency	20	0.01 to 0.7	5 to 3000
	25		

#### Low Friction Cylinder (Single Acting) Series MQP

P.1192



Series	Bore size (mm)	Operating pressure range (MPa)	Thrust control standard (N)
<b>MQP</b>	ø4	0.001 to 0.7 (Except for moving parts mass)	0.01 to 8
	ø6		0.03 to 19
	ø10		0.08 to 50
	ø16		0.20 to 140
	ø20		0.30 to 200

REA

REB

REC

C□Y

C□X

**MQ**

RHC

RZQ

D-□

-X□

Individual  
-X□

# Low pressure actuation

Minimal sliding resistance allows low pressure actuation at 0.005 MPa.  
\* Contact SMC regarding vacuum applications.

# Long service life

Long service life of 10,000 km or 100 million full cycles.

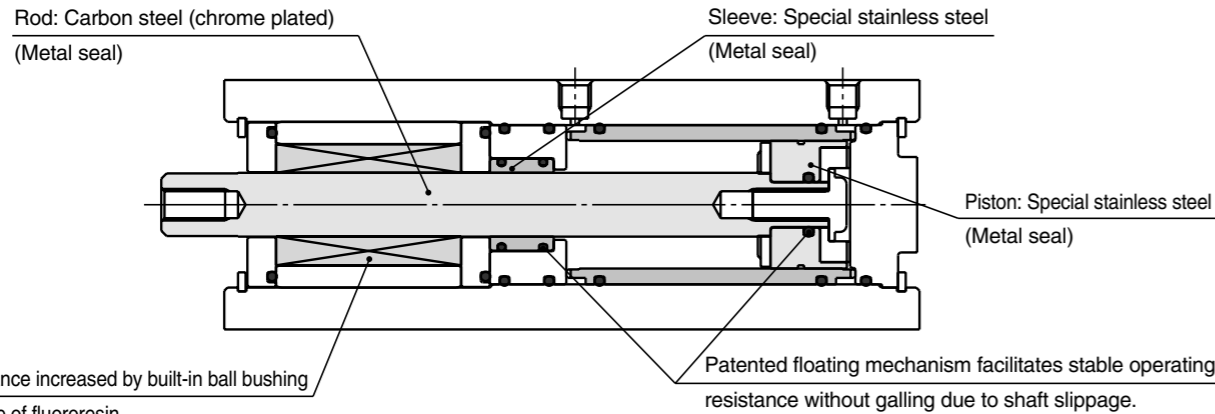

Lateral load resistance increased by built-in ball bushing  
\* MQQT type made of fluororesin.

# Low friction

Low sliding resistance and high stability allow force control as low as 0.05 N. (Based on cylinder Piston area x Pressure accuracy)  
No increased sliding resistance after not operating for a long period of time.

## Series Variation

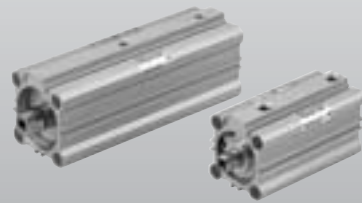

### Series MQQ

Compact low friction cylinders designed for low pressure, low speed, uniform speed or low friction applications

Series	Bore size (mm)	Stroke (mm)								Operating pressure range (MPa)	Actuation speed (mm/s)
		10	20	30	40	50	60	75	100		
MQQT Standard type	10	•	•	•	•	•	•	•	•	0.005 to 0.5	0.3 to 300
	16	•	•	•	•	•	•	•	•		
MQQL Lateral load resisting type (Built-in ball bushing)	20	•	•	•	•	•	•	•	•	0.005 to 0.7	0.5 to 500
	25	•	•	•	•	•	•	•	•		
	30	•	•	•	•	•	•	•	•		
	40	•	•	•	•	•	•	•	•		

### Series MQM

Lateral load resisting low friction cylinders for low pressure, low speed, uniform speed, low friction high pressure, high speed and high speed response (high frequency) actuation

Series	Bore size (mm)	Stroke (mm)						Operating pressure range (MPa)	Actuation speed (mm/s)
		15	30	45	60	75	100		
MQML Standard type	6 (standard only)	•	•	•	•	•	•	ø6: 0.02 to 0.7 ø10 to ø25: 0.005 to 0.7	0.5 to 1000
	10	•	•	•	•	•	•		
MQML□□H High speed/frequency	16	•	•	•	•	•	•	0.01 to 0.7	5 to 3000
	20	•	•	•	•	•	•		
	25	•	•	•	•	•	•		

# Low Friction Cylinders (Metal Seal Type)

## Series MQQ Series MQM

/ ø10, ø16, ø20, ø25, ø30, ø40

/ ø6, ø10, ø16, ø20, ø25

Metal seal structure with low sliding speed and an output control, which resistance enables to cover the range of a driving were not available with the general cylinder.

# Low and uniform speed actuation

Smooth, uniform speed actuation ranges as low as 0.3 mm/s.

# High speed, High frequency actuation

H type achieves speeds up to 3,000 mm/s (without fixed orifice), and continuous actuation up to 50 cycles per second. (MQML□□H)

\*Refer to page 1191 for kinetic energy.

## Application Examples

For pressure controlling with fine pressure variations

Applicable models: MQQT/MQML

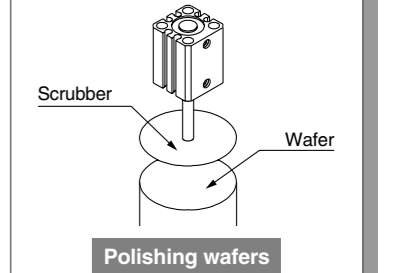

Polishing wafers

For cutting glasses and lenses, requiring constant force

Applicable models: MQQL/MQML

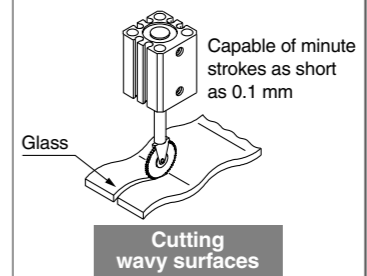

Cutting wavy surfaces

Tension controlling responding to very low pressure and minute pressure variations

Applicable models: MQQL/MQML

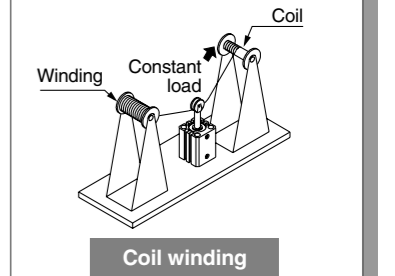

Coil winding

For transferring precision components, etc., that require low or uniform speed actuation

Applicable models: MQQT/MQML

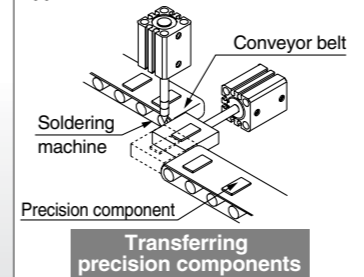

Transferring precision components

For eliminating non-conforming articles requiring high speed actuation

Applicable models: MQML/MQML□□H

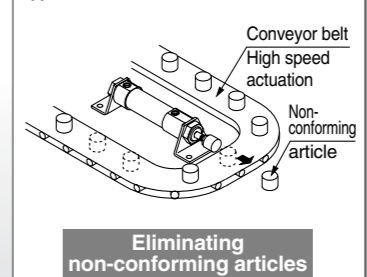

Eliminating non-conforming articles

For punching operations requiring high frequency actuation

Applicable models: MQML/MQML□□H

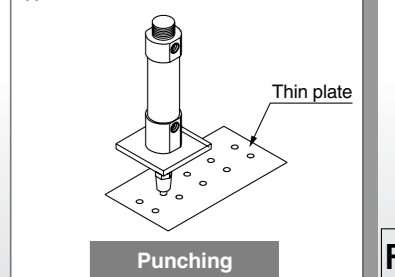

Punching

## Recommended Circuit Examples

Example 1) Uniform & low speed actuation (no control of cylinder output)

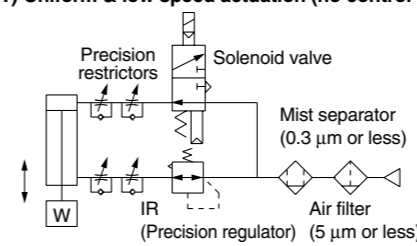

\* When using a solenoid valve, use a metal seal type (Series VQ, VQZ, SQ, etc.).

Example 2) Low speed with output control

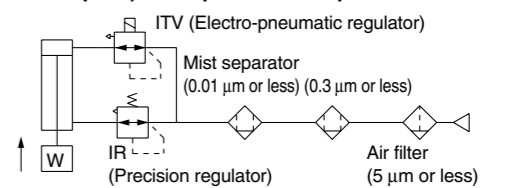

\* When performing control of cylinder output, do not create a restriction circuit using a speed controller, etc. Pressure inside the cylinder will drop and control will become impossible. Always control actuation by means of pressure control.

Example 3) High speed & high frequency actuation

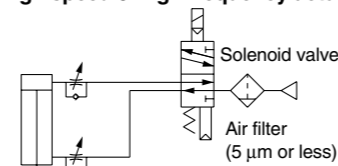

\* When using a solenoid valve, use a metal seal type (Series VQ, VQZ, SQ, etc.).

Applications based on low friction specification

- Operating resistance will vary with an offset load. Be sure to properly align the rod axis with the load and direction of movement when connecting. When an offset load is expected, provide a suitable mechanism such as a floating joint.
- Use clean air (atmospheric pressure dew point temperature -10°C or less). Using the AM series mist separator (nominal filtration rating of 0.3 µm or less), or the AM + AMD series (nominal filtration rating of 0.01 µm or less) is recommended.

REA  
REB  
REC  
C□Y  
C□X  
MQ  
RHC  
RZQ  
D-□  
-X□  
Individual  
-X□



# Low Friction Cylinder (Metal Seal Type/Single Acting)

## Series MQF / $\phi 4, \phi 6, \phi 10, \phi 16, \phi 20$

Fully covers a pressure force control range of 0.01 N to 200 N

### No lurching

Even extremely small degree lurching such as 0.01 mm does not occur. A special air supply, such as for static bearings, is not required.

### No piston

Sliding resistance is drastically decreased because the piston and the rod share the same shaft.

### Special single acting/Piston retraction by external force

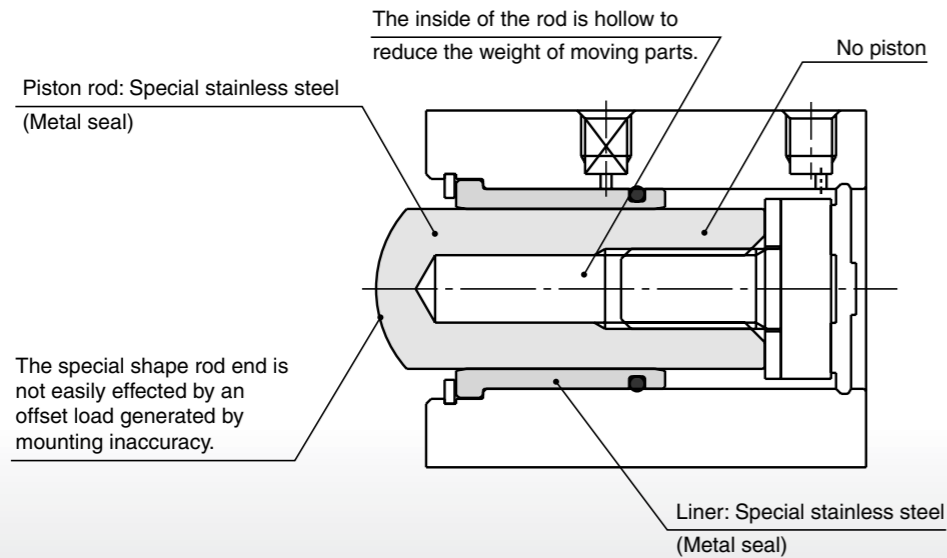
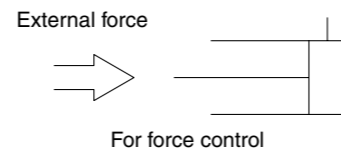

### Reduced thrust dispersion

Dispersion of piston diameter: 3  $\mu\text{m}$  or less  
Readjusting thrust is not necessary when the cylinder is replaced.  
Dispersion of thrust does not occur even more than one cylinder is connected to the same circuit, either. (Depends on the operation environment.)

### Low friction and soft-touching

Possible to control the output in increments of 0.01 N. (Depends on the piston area of a cylinder x pressure accuracy)  
In addition, sliding resistance does not change after periods of non-operation.

### High-precision linear control

Delicate and precise linear movement control is possible.

### Series MQP

Low friction cylinder suitable for low friction, force control.

Bore size [mm] (Pressure receiving diameter)	Stroke [mm]	Operating pressure range [MPa]	Mass of moving parts [g]	Thrust control standard [N]
$\phi 4$	10	0.001 to 0.7 (Excluding the mass of moving parts)	4	0.01 to 8
$\phi 6$			8	0.03 to 19
$\phi 10$			24	0.08 to 50
$\phi 16$			62	0.20 to 140
$\phi 20$			103	0.30 to 200

### Application Examples: For force control responding to a slight pressure fluctuation

#### Application examples for a single acting model

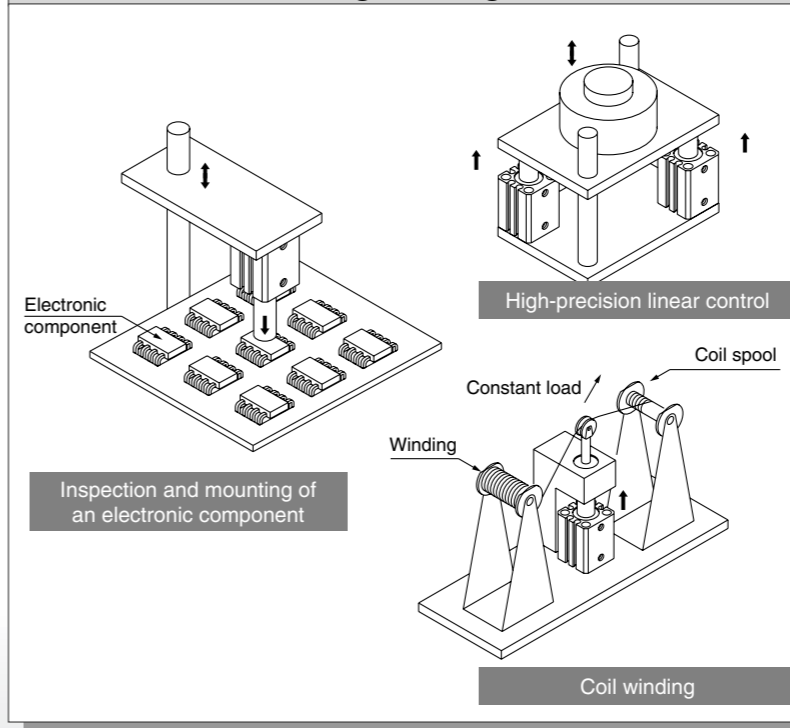

#### Application example for a double acting model

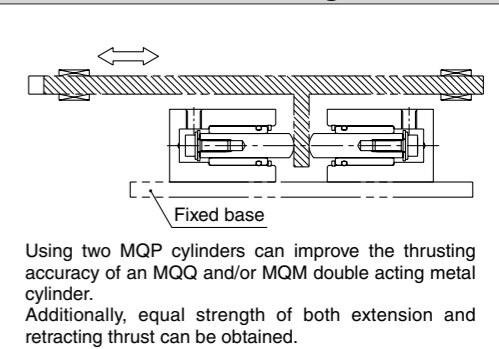

### Recommended Circuit Examples

#### Example 1) Normal operation

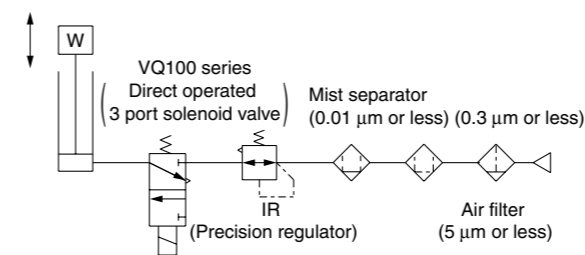

#### Example 2) Soft-touch operation

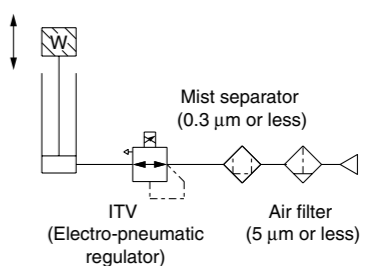

- When using a solenoid valve, SMC recommends you use the VQ100 series in which the lubricant in the main valve will not flow out.
- Do not use a speed controller in the circuit. If it is used, accurate thrust control may not be possible because the internal pressure of a cylinder will drop. Be sure to employ pressure control for control operations.

#### Made to Order

- Vacuum retraction cylinder
- Single acting, spring return type (Built-in springs)
- No exterior leakage (For clean rooms)
- Tubing with a maximum of  $\phi 40$  (I.D.) is available.

Metal Seal

# Compact Low Friction Cylinder

## Series *MQQ*

ø10, ø16, ø20, ø25, ø30, ø40

### How to Order

**MQQ T B 10 - 10 D**

**Compact low friction specification**

Type	
T	Standard type
L	Lateral load resisting type (Built-in ball bushing)

**Mounting**

B	Through hole & Double end tapped (Standard)
L	Foot type
F	Rod side flange type
G	Head side flange type
D <sup>Note)</sup>	Double clevis type

Note) Available with the MQQL□ only.  
\* Mounting brackets are included when shipped, but unassembled.

**Bore size**

10	10 mm
16	16 mm
20	20 mm
25	25 mm
30	30 mm
40	40 mm

**Body option**

Nil	Standard (Rod end female thread)
M <sup>Note)</sup>	Rod end male thread

Note) A rod end thread adapter is attached.  
\* A rod end thread adapter is shipped being assembled.

**Action**

D	Double acting
---	---------------

**Cylinder stroke**

Bore size (mm)	Standard stroke (mm)
10	10, 20, 30, 40
16	10, 20, 30, 40, 50, 60
20	10, 20, 30, 40, 50, 60
25	10, 20, 30, 40, 50, 75, 100
30	10, 20, 30, 40, 50, 75, 100
40	10, 20, 30, 40, 50, 75, 100

\* Strokes are available in 1 mm increments by installing a spacer in standard stroke cylinders.

**Port thread type**

Nil	M thread	ø10 to ø20
	Rc	
TN	NPT	ø25 to ø40
TF	G	

 \* The MQQ series is not auto switch capable.

### Mounting Bracket Part No.

Bore size (mm)	Foot <sup>Note 1)</sup>	Flange	Double clevis	Rod end thread adapter (with nut)
10	CQS-L016	CQS-F016	CQS-D016	MQ10-M
16	CQS-L020	CQS-F020	CQS-D020	MQ16-M
20	CQS-L025	CQS-F025	CQS-D025	MQ20-M
25	MQ-L032	MQ-F032	MQ-D032	MQ25-M
30	MQ-L040	MQ-F040	MQ-D040	MQ28-M
40	CQ-L050	CQ-F050	MQ-D050	

Note 1) When ordering a foot bracket, order 2 pcs. for each cylinder.

Note 2) The following parts are included with a bracket respectively.

Foot, Flange ..... Body mounting bolts

Double clevis ..... Clevis pin, C type retaining ring for shaft, Body mounting bolts



**Specifications: Standard Type/MQQT**



Bore size (mm)		10	16	20	25	30	40
<b>Seal construction</b>		Metal seal					
<b>Action</b>		Double acting, Single rod					
<b>Fluid</b>		Air					
<b>Proof pressure</b>		1.05 MPa					
<b>Maximum operating pressure</b>		0.5 MPa					
<b>Minimum operating pressure</b> <small>Note 1)</small>		0.005 MPa					
<b>Ambient and fluid temperature</b>		-10 to 80°C					
<b>Cushion</b>		Rubber bumper (Standard)					
<b>Lubrication</b> <small>Note 2)</small>		Not required (Non-lube)					
<b>Rod end thread</b>		Female thread					
<b>Stroke length tolerance</b>		+1.0 0					
<b>Piston speed</b> <small>Note 3)</small>		0.3 to 300 mm/s (Refer to page 1190.)					
<b>Total allowable leakage</b>	<b>Supply pressure 0.1 MPa</b>	150 cm <sup>3</sup> /min or less	200 cm <sup>3</sup> /min or less	300 cm <sup>3</sup> /min or less	400 cm <sup>3</sup> /min or less	400 cm <sup>3</sup> /min or less	400 cm <sup>3</sup> /min or less
	<b>Supply pressure 0.3 MPa</b>	800 cm <sup>3</sup> /min or less	1000 cm <sup>3</sup> /min or less	1200 cm <sup>3</sup> /min or less	1600 cm <sup>3</sup> /min or less	1600 cm <sup>3</sup> /min or less	1600 cm <sup>3</sup> /min or less
	<b>Supply pressure 0.5 MPa</b>	1500 cm <sup>3</sup> /min or less	2000 cm <sup>3</sup> /min or less	3000 cm <sup>3</sup> /min or less	4000 cm <sup>3</sup> /min or less	4000 cm <sup>3</sup> /min or less	4000 cm <sup>3</sup> /min or less

Note 1) Value when horizontal. (Use clean, dry, and nonfreezing air) However, as the stroke increases, it will likely be affected by the mass of its moving parts and the pressure will likely increase by approx. 0.003 to 0.005 MPa due to an offset load from the mass of the rod.

Note 2) Refer to precautions on page 1189 regarding lubrication.

Note 3) Control low speed actuation with differential pressure and a speed controller, etc. (Refer to recommended circuit examples on page 1169 for further details.)

**Symbol**

Double acting, Single rod

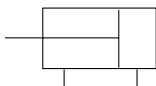

**Specifications: Lateral Load Resisting Type/MQQL**

Bore size (mm)		10	16	20	25	30	40
<b>Seal construction</b>		Metal seal					
<b>Action</b>		Double acting, Single rod					
<b>Fluid</b>		Air					
<b>Proof pressure</b>		1.05 MPa					
<b>Maximum operating pressure</b>		0.7 MPa					
<b>Minimum operating pressure</b> <small>Note 1)</small>		0.005 MPa					
<b>Ambient and fluid temperature</b>		-10 to 80°C					
<b>Cushion</b>		Rubber bumper (Standard)					
<b>Lubrication</b> <small>Note 2)</small>		Not required (Non-lube)					
<b>Rod end thread</b>		Female thread					
<b>Stroke length tolerance</b>		+1.0 0					
<b>Piston speed</b> <small>Note 3)</small>		0.5 to 500 mm/s (Refer to page 1190.)					
<b>Total allowable leakage</b>	<b>Supply pressure 0.1 MPa</b>	150 cm <sup>3</sup> /min or less	200 cm <sup>3</sup> /min or less	300 cm <sup>3</sup> /min or less	400 cm <sup>3</sup> /min or less	400 cm <sup>3</sup> /min or less	400 cm <sup>3</sup> /min or less
	<b>Supply pressure 0.3 MPa</b>	800 cm <sup>3</sup> /min or less	1000 cm <sup>3</sup> /min or less	1200 cm <sup>3</sup> /min or less	1600 cm <sup>3</sup> /min or less	1600 cm <sup>3</sup> /min or less	1600 cm <sup>3</sup> /min or less
	<b>Supply pressure 0.5 MPa</b>	1500 cm <sup>3</sup> /min or less	2000 cm <sup>3</sup> /min or less	3000 cm <sup>3</sup> /min or less	4000 cm <sup>3</sup> /min or less	4000 cm <sup>3</sup> /min or less	4000 cm <sup>3</sup> /min or less

Note 1) Value when horizontal. (Use clean, dry, and nonfreezing air) However, as the stroke increases, it will likely be affected by the mass of its moving parts and the pressure will likely increase by approx. 0.003 to 0.005 MPa due to an offset load from the mass of the rod.

Note 2) Refer to precautions on page 1189 regarding lubrication.

Note 3) Control low speed actuation with differential pressure and a speed controller, etc. (Refer to recommended circuit examples on page 1169 for further details.)

**Mass: Standard Type/MQQT**

Unit: g

Bore size (mm)	Cylinder stroke (mm)							
	10	20	30	40	50	60	75	100
10	94	118	142	166	—	—	—	—
16	166	206	246	286	326	366	—	—
20	228	290	352	414	476	538	—	—
25	395	487	579	671	763	—	993	1223
30	479	567	655	743	831	—	1052	1272
40	728	846	964	1082	1200	—	1495	1790

**Mass: Lateral Load Resisting Type/MQQL (Built-in Ball Bushing)**

Unit: g

Bore size (mm)	Cylinder stroke (mm)							
	10	20	30	40	50	60	75	100
10	148	172	196	220	—	—	—	—
16	284	324	364	404	444	484	—	—
20	383	445	507	569	631	693	—	—
25	552	644	736	828	920	—	1150	1380
30	911	999	1087	1175	1263	—	1485	1705
40	1337	1455	1573	1691	1809	—	2104	2399

**Theoretical Output**



Unit: N

Bore size (mm)	Rod size (mm)	Direction	Piston area (mm <sup>2</sup> )	Operating pressure (MPa)						
				0.1	0.2	0.3	0.4	0.5	0.6	0.7
10	6	IN	50.3	5.0	10.1	15.1	20.1	25.2	30.2	35.2
		OUT	78.5	7.9	15.7	23.6	31.4	39.3	47.1	55.0
16	8	IN	145.8	14.9	29.2	43.7	58.3	72.9	87.5	102.1
		OUT	196.1	19.6	39.2	58.9	78.4	98.1	117.7	137.3
20	10	IN	235.6	23.6	47.1	70.7	94.2	117.8	141.4	164.9
		OUT	314.2	31.4	62.8	94.3	125.7	157.1	188.5	219.9
25	12	IN	377.8	37.8	75.6	113.3	151.1	188.9	226.7	262.5
		OUT	490.9	49.1	98.2	147.3	196.4	245.5	294.5	343.6
30	16	IN	505.8	50.6	101.2	151.8	202.4	253.0	303.6	354.2
		OUT	706.9	70.7	141.4	212.1	282.8	353.5	424.2	494.9
	40	IN	1055.6	105.6	211.2	316.8	422.4	528.0	633.6	739.2
		OUT	1256.6	125.7	251.4	377.1	502.8	628.5	754.2	879.9

REA

REB

REC

C□Y

C□X

MQ

RHC

RZQ

D-□

-X□

Individual

-X□

# Series MQQ

## Construction

### Standard type: MQQT

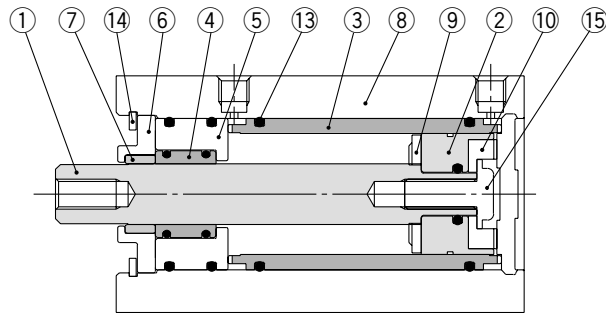

### Lateral load resisting type: MQQL (Built-in ball bushing)

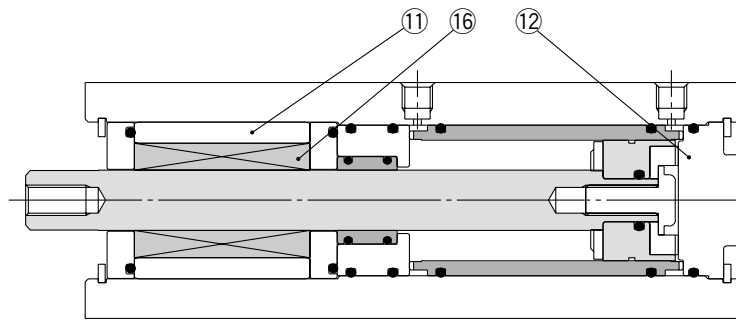

### Component Parts

No.	Description	Material	Note
1	Rod	Carbon steel	Hard chrome plated
2	Piston	Special stainless steel	
3	Liner	Special stainless steel	
4	Sleeve	Special stainless steel	
5	Sleeve retainer	Aluminum alloy	
6	Plate	Aluminum alloy	Hard anodized
7	Guide	Fluororesin	
8	Cylinder tube	Aluminum alloy	Hard anodized
9	Bumper A	Polyurethane	
10	Bumper B	Polyurethane	
11	Bushing	Aluminum alloy	
12	Bottom plate	Aluminum alloy	Hard anodized
13	O-ring	NBR	
14	Retaining ring	Carbon tool steel	Phosphate coated
15	Bolt	Carbon tool steel	Chromated
16	Ball bushing		

## Mounting

### Mounting bolts

#### a) Mounting type A (when using the mounting plate threads)

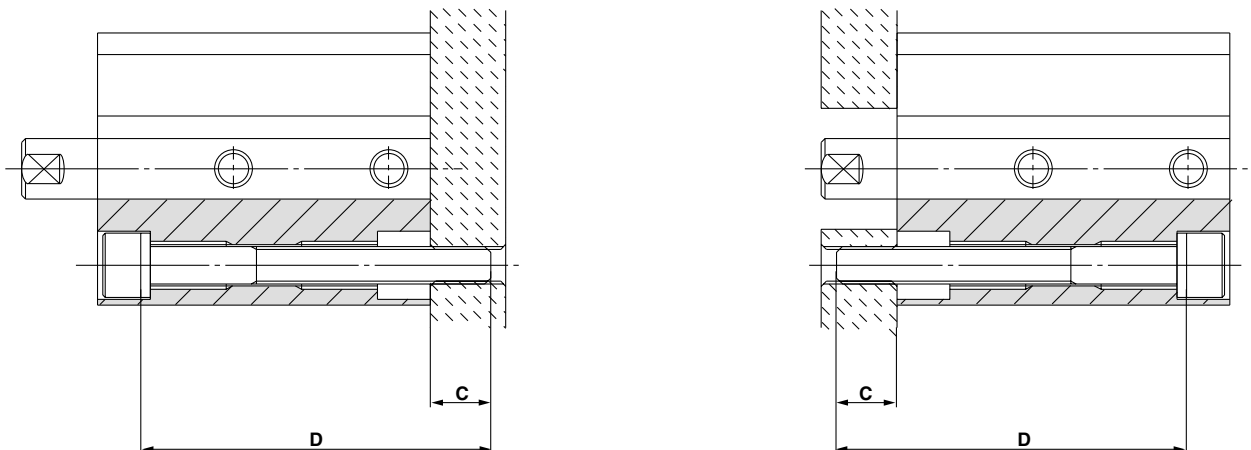

Note) Be sure to use a flat washer for the A type mounting.

#### b) Mounting type B (when using the cylinder tube threads)

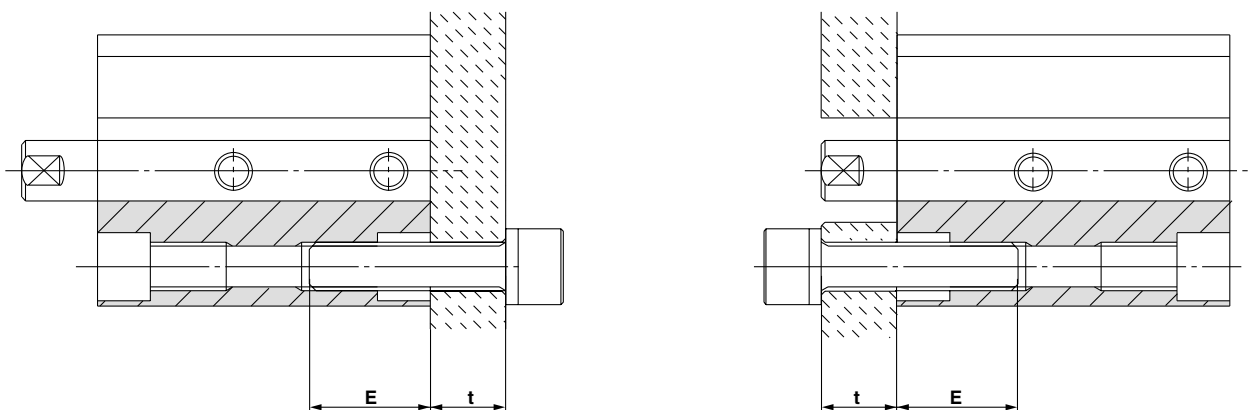

### Compatible Mounting Bolt Dimensions

Model	Mounting type A			Mounting type B		
	Mounting bolt size	C (mm)	D: Bolt length (mm)	Mounting bolt size	E (mm)	
Standard type MQQT	MQQTB10-□D	M3 x 0.5	7	35 + Stroke	M4 x 0.7	8 to 11
	MQQTB16-□D	M5 x 0.8	7	35 + Stroke	M6 x 1	13 to 17
	MQQTB20-□D		8.5	40 + Stroke		
	MQQTB25-□D		9	45 + Stroke		
	MQQTB30-□D		7.5	50 + Stroke		
	MQQTB40-□D	M6 x 1	6	50 + Stroke	M8 x 1.25	16 to 22
Lateral load resisting type MQQL (Built-in ball bushing)	MQQLB10-□D	M3 x 0.5	7	65 + Stroke	M4 x 0.7	8 to 11
	MQQLB16-□D	M5 x 0.8	5.5	70 + Stroke	M6 x 1	13 to 17
	MQQLB20-□D		8	80 + Stroke		
	MQQLB25-□D		6.5	85 + Stroke		
	MQQLB30-□D		7	105 + Stroke		
	MQQLB40-□D	M6 x 1	7	105 + Stroke	M8 x 1.25	16 to 22

□: Stroke

REA

REB

REC

C□Y

C□X

MQ

RHC

RZQ

D-□

-X□

Individual  
-X□



# Series MQQ

## Dimensions

### Standard type (Through hole & Double end tapped): MQQTB

ø10, ø16, ø20

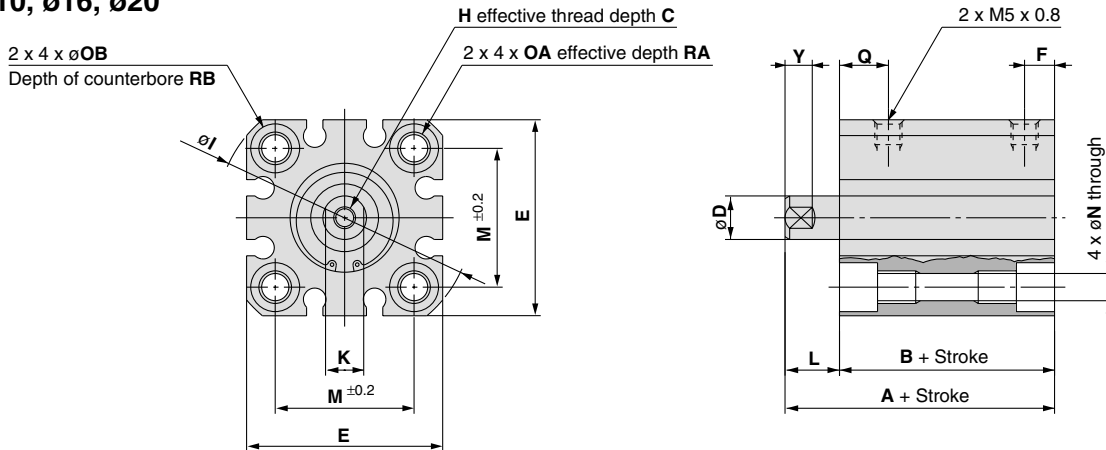

ø25, ø30, ø40

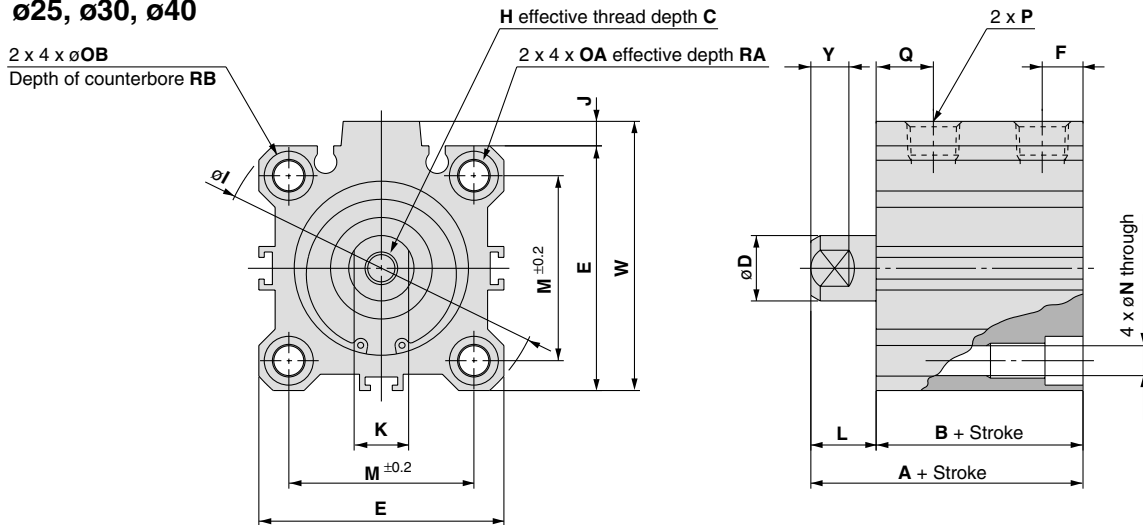

Bore size (mm)	Stroke range (mm)	A	B	C	D (Note)	E	F	H	I	J	K	L	M	N	OA	OB	P			Q	RA	RB	W	Y
																	—	TN	TF					
10	10 to 40	39.5	31.5	6	6 ( 5.8)	29	5.5	M3 x 0.5	38	—	5	8	20	3.5	M4 x 0.7	6.5	—	—	—	14.5	7	4	—	5
16	10 to 60	44	34	8	8 ( 7.8)	36	5.5	M4 x 0.7	47	—	7	10	25.5	5.4	M6 x 1.0	9	—	—	—	18	10	7	—	5
20	10 to 60	47.5	37.5	10	10 ( 9.8)	40	5.5	M5 x 0.8	52	—	8	10	28	5.4	M6 x 1.0	9	—	—	—	19.5	10	7	—	6
25	10 to 50, 75, 100	54	42	12	12 (11.8)	45	8.5	M6 x 1.0	60	4.5	10	12	34	5.5	M6 x 1.0	9	Rc 1/8	NPT 1/8	G 1/8	23	10	7	49.5	7
30	10 to 50, 75, 100	60.5	48.5	13	16 (15.8)	52	8.5	M8 x 1.25	69	5	14	12	40	5.5	M6 x 1.0	9	Rc 1/8	NPT 1/8	G 1/8	26	10	7	57	10
40	10 to 50, 75, 100	62	50	13	16 (15.8)	64	12	M8 x 1.25	86	7	14	12	50	6.6	M8 x 1.25	11	Rc 1/4	NPT 1/4	G 1/4	26	14	8	71	10

Note) ( ): Rod end dimensions

### With rod end male thread: MQQ□-□DM

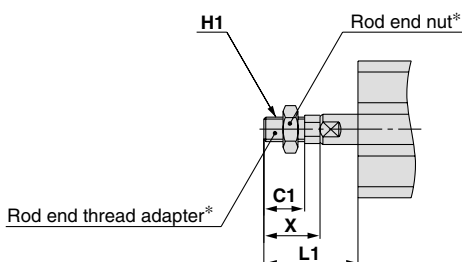

Bore size (mm)	L1	C1	H1	X
10	23.5	10.5	M5 x 0.8	15.5
16	26.5	11.5	M6 x 1.0	16.5
20	28.5	13.5	M8 x 1.25	18.5
25	34.5	16.5	M10 x 1.25	22.5
30	40.5	22.5	M14 x 1.5	28.5
40	40.5	22.5	M14 x 1.5	28.5

\* Refer to page 1180 for details regarding the rod end thread adapter and the rod end nut.

Foot type: MQQTL  
ø10, ø16, ø20

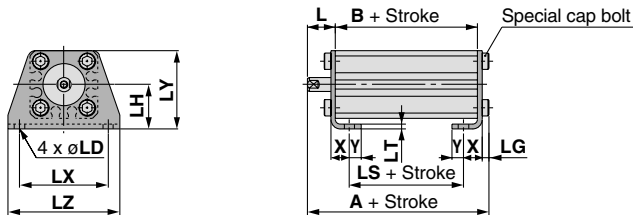

ø25, ø30, ø40

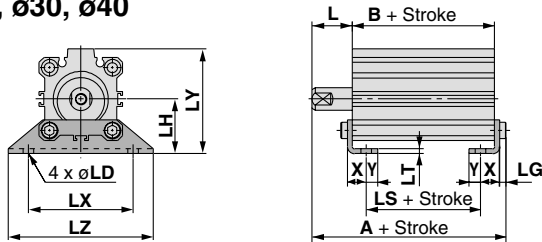

Bore size (mm)	Stroke range (mm)	A	B	L	LD	LG	LH
10	10 to 40	44.3	31.5	8	4.5	2.8	19
16	10 to 60	51.2	34	10	6.6	4	24
20	10 to 60	54.7	37.5	10	6.6	4	26
25	10 to 50,75,100	61.2	42	12	6.6	4	30
30	10 to 50,75,100	67.7	48.5	12	6.6	4	33
40	10 to 50,75,100	70.2	50	12	9	5	39

Bore size (mm)	LS	LT	LX	LY	LZ	X	Y
10	19.5	2	38	33.5	48	8	5
16	22	3.2	48	42	62	9.2	5.8
20	22.5	3.2	52	46	66	10.7	5.8
25	26	3.2	57	57	71	11.2	5.8
30	32.5	3.2	64	64	78	11.2	7
40	27	3.2	79	78	95	14.7	8

Rod side flange type: MQQTF  
ø10, ø16, ø20

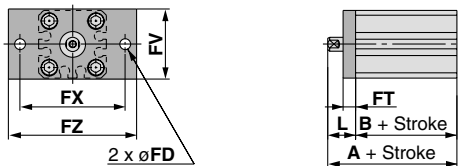

ø25, ø30, ø40

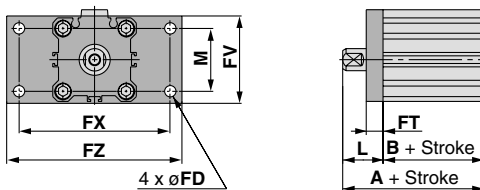

Bore size (mm)	Stroke range (mm)	A	B	FD	FT	FV	FX
10	10 to 40	49.5	31.5	4.5	5.5	30	45
16	10 to 60	54	34	6.6	8	39	48
20	10 to 60	57.5	37.5	6.6	8	42	52
25	10 to 50,75,100	64	42	5.5	8	48	56
30	10 to 50,75,100	70.5	48.5	5.5	8	54	62
40	10 to 50,75,100	72	50	6.6	9	67	76

Bore size (mm)	FZ	L	M
10	55	18	—
16	60	20	—
20	64	20	—
25	65	22	34
30	72	22	40
40	89	22	50

Head side flange type: MQQTG  
ø10, ø16, ø20

ø25, ø30, ø40

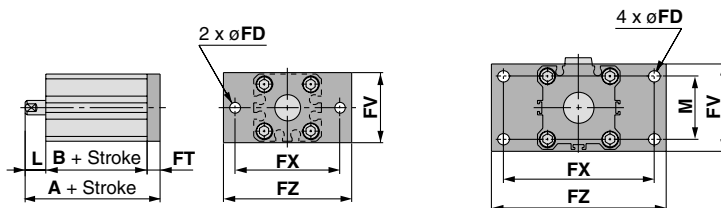

Bore size (mm)	Stroke range (mm)	A	L
10	10 to 40	45	8
16	10 to 60	52	10
20	10 to 60	55.5	10
25	10 to 50,75,100	62	12
30	10 to 50,75,100	68.5	12
40	10 to 50,75,100	70	12

(Dimensions other than A and L are the same as the rod side flange type.)

REA

REB

REC

C□Y

C□X

MQ

RHC

RZQ

D-□

-X□

Individual  
-X□

# Series MQQ

## Dimensions

### Lateral load resisting type (Through hole & Double end tapped): MQQLB $\phi 10, \phi 16, \phi 20$

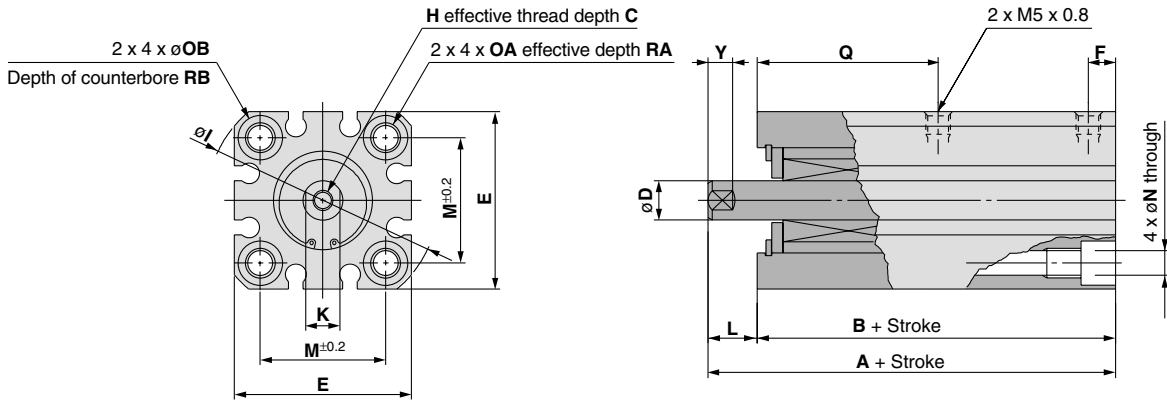

### $\phi 25, \phi 30, \phi 40$

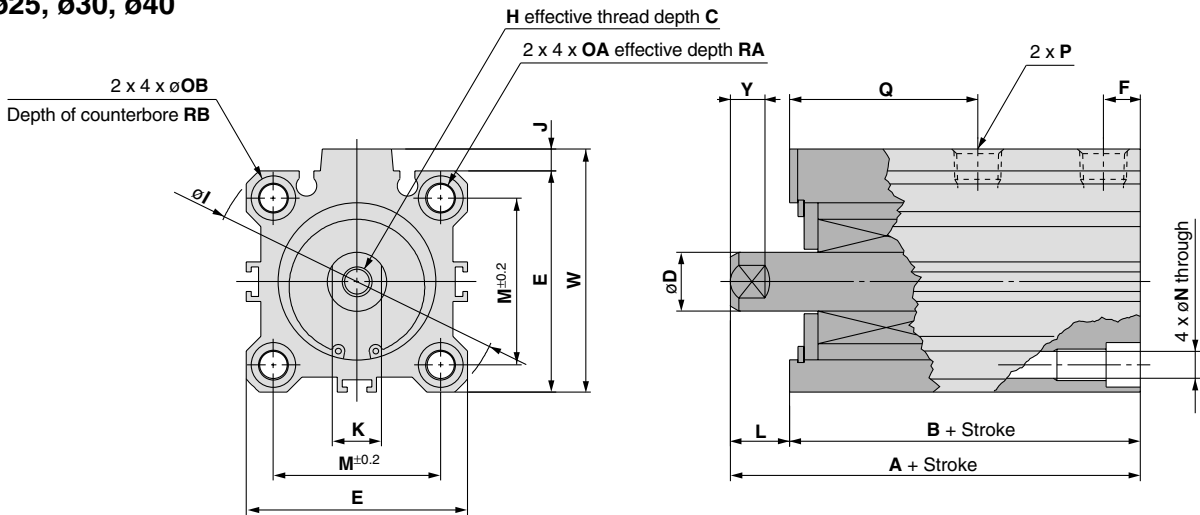

Bore size (mm)	Stroke range (mm)	A	B	C	D (Note)	E	F	H	I	J	K	L	M	N	OA	OB	P			Q	RA	RB	W	Y
																	—	TN	TF					
10	10 to 40	69.5	61.5	6	6 ( 5.8)	29	9	M3 x 0.5	38	—	5	8	20	3.5	M4 x 0.7	6.5	—	—	—	39.5	7	4	—	5
16	10 to 60	80.5	70.5	8	8 ( 7.8)	36	11.5	M4 x 0.7	47	—	7	10	25.5	5.4	M6 x 1.0	9	—	—	—	48.5	10	7	—	5
20	10 to 60	89	79	10	10 ( 9.8)	40	12	M5 x 0.8	52	—	8	10	28	5.4	M6 x 1.0	9	—	—	—	55	10	7	—	6
25	10 to 50, 75, 100	96.5	84.5	12	12 (11.8)	45	13.5	M6 x 1.0	60	4.5	10	12	34	5.5	M6 x 1.0	9	Rc 1/8	NPT 1/8	G 1/8	58	10	7	49.5	7
30	10 to 50, 75, 100	116	104	13	16 (15.8)	52	17.5	M8 x 1.25	69	5	14	12	40	5.5	M6 x 1.0	9	Rc 1/8	NPT 1/8	G 1/8	71	10	7	57	10
40	10 to 50, 75, 100	116	104	13	16 (15.8)	64	17.5	M8 x 1.25	86	7	14	12	50	6.6	M8 x 1.25	11	Rc 1/4	NPT 1/4	G 1/4	71	14	8	71	10

Note) ( ): Rod end dimensions

### With rod end male thread: MQQ□-□DM

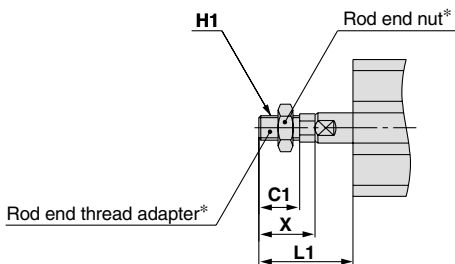

Bore size (mm)	L1	C1	H1	X
10	23.5	10.5	M5 x 0.8	15.5
16	26.5	11.5	M6 x 1.0	16.5
20	28.5	13.5	M8 x 1.25	18.5
25	34.5	16.5	M10 x 1.25	22.5
30	40.5	22.5	M14 x 1.5	28.5
40	40.5	22.5	M14 x 1.5	28.5

\* Refer to page 1180 for details regarding the rod end thread adapter and the rod end nut.

**Foot type: MQQLL**  
ø10, ø16, ø20

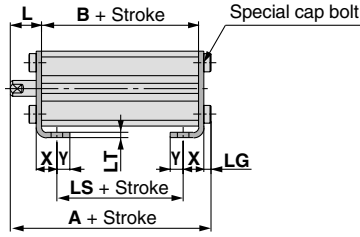
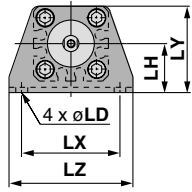

ø25, ø30, ø40

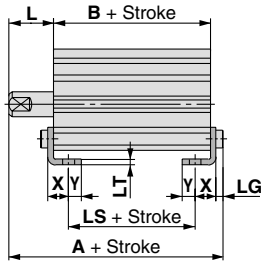
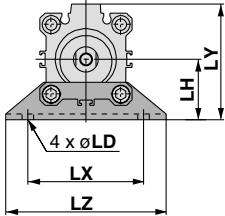

**Rod side flange type: MQQLF**  
ø10, ø16, ø20

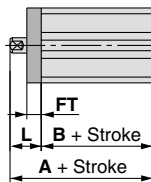
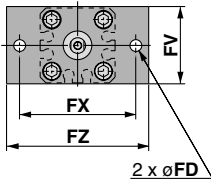

ø25, ø30, ø40

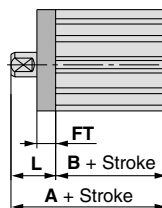
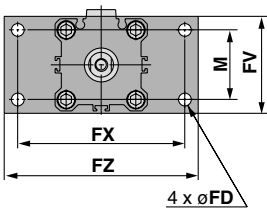

**Head side flange type: MQQLG**  
ø10, ø16, ø20

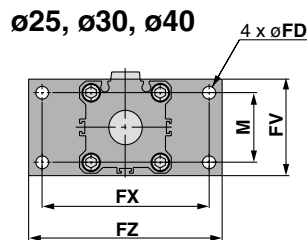
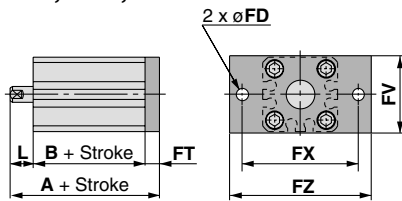

**Double clevis type: MQQLD**

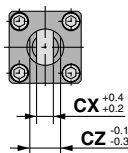
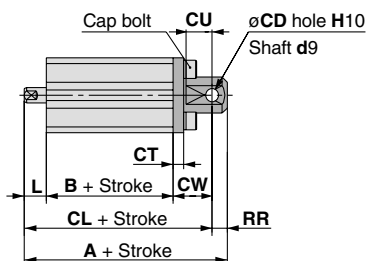

(mm)

Bore size (mm)	Stroke range (mm)	A	B	L	LD	LG	LH
10	10 to 40	74.3	61.5	8	4.5	2.8	19
16	10 to 60	87.7	70.5	10	6.6	4	24
20	10 to 60	96.2	79	10	6.6	4	26
25	10 to 50,75,100	103.7	84.5	12	6.6	4	30
30	10 to 50,75,100	123.2	104	12	6.6	4	33
40	10 to 50,75,100	124.2	104	12	9	5	39

Bore size (mm)	LS	LT	LX	LY	LZ	X	Y
10	49.5	2	38	33.5	48	8	5
16	58.5	3.2	48	42	62	9.2	5.8
20	64	3.2	52	46	66	10.7	5.8
25	68.5	3.2	57	57	71	11.2	5.8
30	88	3.2	64	64	78	11.2	7
40	81	3.2	79	78	95	14.7	8

(mm)

Bore size (mm)	Stroke range (mm)	A	B	FD	FT	FV	FX
10	10 to 40	79.5	61.5	4.5	5.5	30	45
16	10 to 60	90.5	70.5	6.6	8	39	48
20	10 to 60	99	79	6.6	8	42	52
25	10 to 50,75,100	106.5	84.5	5.5	8	48	56
30	10 to 50,75,100	126	104	5.5	8	54	62
40	10 to 50,75,100	126	104	6.6	9	67	76

Bore size (mm)	FZ	L	M
10	55	18	—
16	60	20	—
20	64	20	—
25	65	22	34
30	72	22	40
40	89	22	50

(mm)

Bore size (mm)	Stroke range (mm)	A	L
10	10 to 40	75	8
16	10 to 60	88.5	10
20	10 to 60	97	10
25	10 to 50,75,100	104.5	12
30	10 to 50,75,100	124	12
40	10 to 50,75,100	124	12

(Dimensions other than A and L are the same as the rod side flange type.)

(mm)

Bore size (mm)	Stroke range (mm)	A	B	CD	CL	CT	CU
10	10 to 40	90.5	61.5	5	84.5	4	10
16	10 to 60	107.5	70.5	8	98.5	5	12
20	10 to 60	119	79	10	109	5	14
25	10 to 50,75,100	126.5	84.5	10	116.5	5	14
30	10 to 50,75,100	148	104	10	138	6	14
40	10 to 50,75,100	158	104	14	144	7	20

Bore size (mm)	CW	CX	CZ	L	RR
10	15	6.5	12	8	6
16	18	8	16	10	9
20	20	10	20	10	10
25	20	18	36	12	10
30	22	18	36	12	10
40	28	22	44	12	14

REA

REB

REC

C□Y

C□X

MQ

RHC

RZQ

D-□

-X□

Individual  
-X□

# Series MQQ

## Accessory Dimensions

### Rod end thread adapter

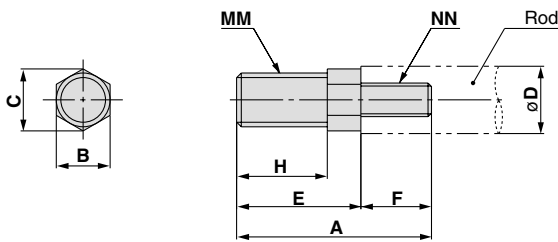

Part no.	Applicable bore size (mm)	A	B	C	D	E	F
<b>MQ10-M</b>	10	20.5	8	9.2	6	15.5	5
<b>MQ16-M</b>	16	22.5	8	9.2	8	16.5	6
<b>MQ20-M</b>	20	24.5	8	9.2	10	18.5	6
<b>MQ25-M</b>	25	33.5	10	11.5	12	22.5	11
<b>MQ28-M</b>	30, 40	40.5	14	16	16	28.5	12

Part no.	Applicable bore size (mm)	H	MM	NN
<b>MQ10-M</b>	10	10.5	M5 x 0.8	M3 x 0.5
<b>MQ16-M</b>	16	11.5	M6 x 1.0	M4 x 0.7
<b>MQ20-M</b>	20	13.5	M8 x 1.25	M5 x 0.8
<b>MQ25-M</b>	25	16.5	M10 x 1.25	M6 x 1.0
<b>MQ28-M</b>	30, 40	22.5	M14 x 1.5	M8 x 1.25

### Rod end nut

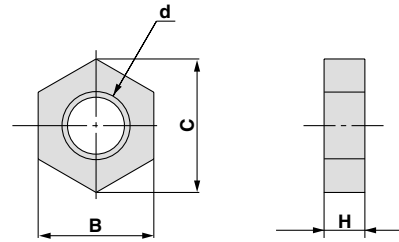

Part no.	Applicable bore size (mm)	B	C	d	H
<b>NTJ-015A</b>	10	8	9.2	M5 x 0.8	4
<b>NT-015A</b>	16	10	11.5	M6 x 1.0	5
<b>NT-02</b>	20	13	15	M8 x 1.25	5
<b>NT-03</b>	25	17	19.6	M10 x 1.25	6
<b>NT-04</b>	30, 40	22	25.4	M14 x 1.5	8

### Clevis pin

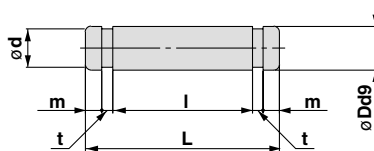

Part no.	Applicable bore size (mm)	Dd9	L	d	l	m	t	Applicable retaining ring
<b>IY-J015</b>	10	5 <sup>-0.030</sup> <sub>-0.040</sub>	16.6	4.8	12.2	1.5	0.7	C type 5 for shaft
<b>IY-G02</b>	16	8 <sup>-0.040</sup> <sub>-0.076</sub>	21	7.6	16.2	1.5	0.9	C type 8 for shaft
<b>IY-G03</b>	20	10 <sup>-0.040</sup> <sub>-0.076</sub>	25.6	9.6	20.2	1.55	1.15	C type 10 for shaft
<b>IY-G04</b>	25, 30	10 <sup>-0.040</sup> <sub>-0.076</sub>	41.6	9.6	36.2	1.55	1.15	C type 10 for shaft
<b>IY-G05</b>	40	14 <sup>-0.050</sup> <sub>-0.093</sub>	50.6	13.4	44.2	2.05	1.15	C type 14 for shaft



# Series MQQ/MQM Specific Product Precautions 1

Be sure to read before handling.

Refer to front matters 42 and 43 for Safety Instructions and pages 3 to 11 for Actuator and Auto Switch Precautions.

## Operation

### Caution

1. When mounting, thoroughly flush out the connector piping and be sure that dirt and chips, etc., do not get inside the cylinder.
2. Install an air filter with a filtration degree of 5 μm or less on the air supply. Furthermore, when controlling for low speed or controlled output, use clean air (atmospheric pressure dew point temperature of -10°C). Installation of a mist separator (filtration degree 0.3 μm or less) is also recommended.
3. Use a metal seal type when using solenoid valves for cylinder actuation. If a rubber seal type is used, there may be an increase in operating resistance due to grease sprayed from the main valve.

4. Operate so that the load applied to the piston rod is normally in the axial direction.

In the event that a lateral load is unavoidable, do not exceed the range of the allowable lateral load at the rod end (refer to pages 1190 and 1191). (Use outside of the operating limits may cause an adverse effect on the life of the unit through problems such as looseness in the guide unit and a loss of precision.)

5. Take care not to scratch or gouge the sliding portion of the rod. This may cause malfunction or shorten the unit's life.

6. When attaching a work piece to the end of the rod, move the rod to the fully retracted position and use the wrench flats at the end of the rod. Fasten the work piece without applying a large amount of torque to the rod.

There are no wrench flats at the end of the rod in the MQM series, so use the attached rod end nut.

7. Be certain to connect a load so that the rod axis is aligned with the load and its direction of movement.

Especially when a cylinder rod is connected directly to a guide function (such as bearings, etc.) on the equipment side, the following is likely to occur. Either an offset load will occur and the sliding resistance will not be stable or galling will occur on the metal seal parts. Therefore, be sure to use a floating joint or a spherical joint.

8. When a piston rod is driven with a circuit from an external force such as force, control, tension control, etc., a stick-slip phenomenon will likely occur and sliding resistance will not be stable if the amount of displacement is 0.05 mm or less.

9. When it is used in locations where a constant vibration is applied, such as a polishing machine, etc., consult with us.

## Disassembly

### Caution

1. The component parts of the metal seal cylinder are manufactured to precision tolerances, and therefore cannot be disassembled.

## Lubrication

### Caution

1. Lubrication of non-lube type cylinder

Do not apply lubrication when controlling for low speed or controlled output. If lubrication is applied, there may be changes in operating resistance due to factors such as the viscosity and surface tension of the oil. Also, use a metal seal type when using solenoid valves for cylinder actuation. If a rubber seal type is used, there may be an increase in operating resistance due to grease sprayed from the main valve.

Lubrication is also unnecessary for high speed actuation, but in the event that lubrication is applied, use turbine oil class 1 (with no additives) ISO VG32. (Do not use spindle oil or machine oil.)

REA

REB

REC

Y

X

**MQ**

RHC

RZQ

D-

-X

Individual  
-X



# Series MQQ/MQM Specific Product Precautions 2

Be sure to read before handling.

Refer to front matters 42 and 43 for Safety Instructions and pages 3 to 11 for Actuator and Auto Switch Precautions.

## Selection

### Series MQQ



### Operating Speed

#### Load Weight and Maximum Speed: MQQT/MQQL

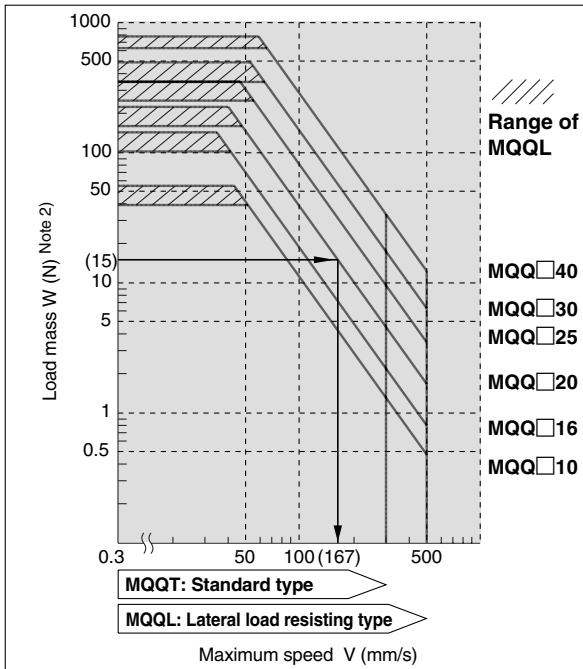

Example)  
Driving a load of 15(N) using the MQQT20 with a maximum speed of 167 (mm/sec)

#### Lateral load resisting type: MQQ□

Bore size (mm)	Allowable kinetic energy (J)
10	0.006
16	0.010
20	0.022
25	0.044
30	0.080
40	0.160

Note 1) When a load is attached to the rod end, adjust the speed so that the maximum speed is no more than that shown in the graph for the corresponding load mass.

Note 2) The mass of cylinder's moving parts is included in the load mass. (See the graph on the right.)

### Moving Parts Mass

#### MQQ□□ Moving Parts Mass

Bore size (mm)	MQQT□: Moving parts mass (g)	MQQL□: Moving parts mass (g)
10	Mass = 8.9 + {3.1 x (stroke/10)}	Mass = 16.7 + {3.1 x (stroke/10)}
16	Mass = 22.9 + {4.0 x (stroke/10)}	Mass = 34.9 + {4.0 x (stroke/10)}
20	Mass = 34.8 + {6.6 x (stroke/10)}	Mass = 57.9 + {6.6 x (stroke/10)}
25	Mass = 66.9 + {8.8 x (stroke/10)}	Mass = 97.7 + {8.8 x (stroke/10)}
30	Mass = 115.0 + {15.8 x (stroke/10)}	Mass = 190.2 + {15.8 x (stroke/10)}
40	Mass = 182.2 + {15.8 x (stroke/10)}	Mass = 257.4 + {15.8 x (stroke/10)}

Note) For the rod side flange type, add 10 mm to the stroke length of the MQQ□F

### Allowable Lateral Load at Rod End

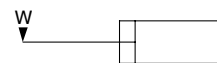

(Mounting orientation: Horizontal)  
supply pressure: 0.5 MPa  
1 N = 0.102 kgf

#### Standard Type: MQQT□

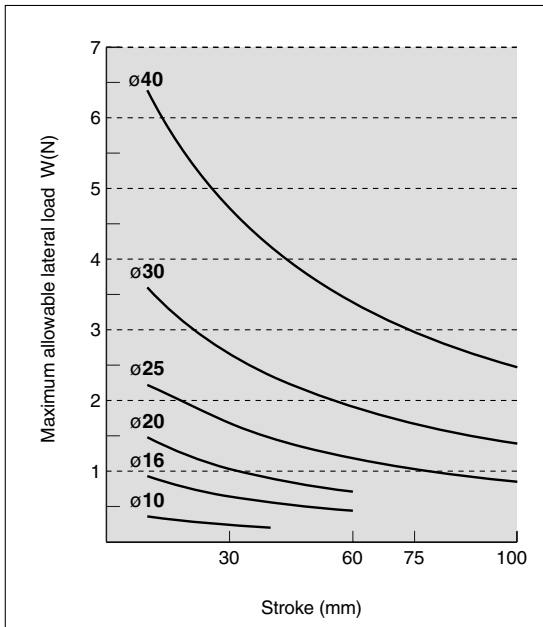

#### Lateral Load Resisting Type: MQQLB/Built-in Ball Bushing

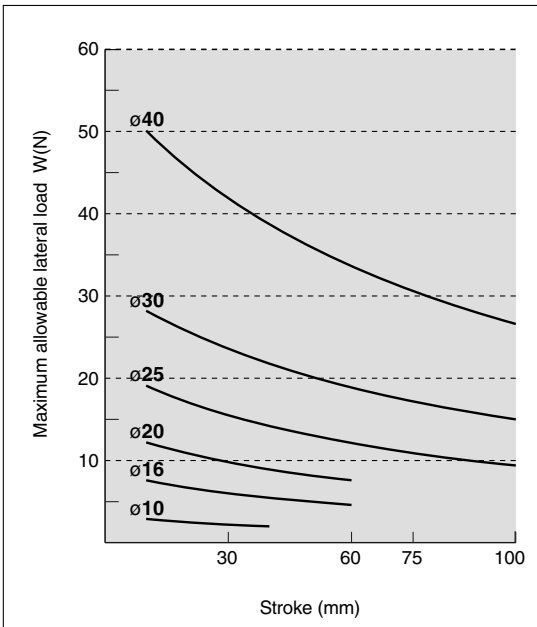

Note 1) The indicated allowable lateral load at the rod end is for the rod end female thread.

Note 2) The allowable lateral load varies depending on the size of a load (the distance to the load's center of gravity). Please contact SMC for further details.





# Series MQQ/MQM Specific Product Precautions 3

Be sure to read before handling.

Refer to front matters 42 and 43 for Safety Instructions and pages 3 to 11 for Actuator and Auto Switch Precautions.

## Selection

### Series MQM

### Caution Operating Speed

#### Load Mass and Maximum Speed: MQML/MQML□□H

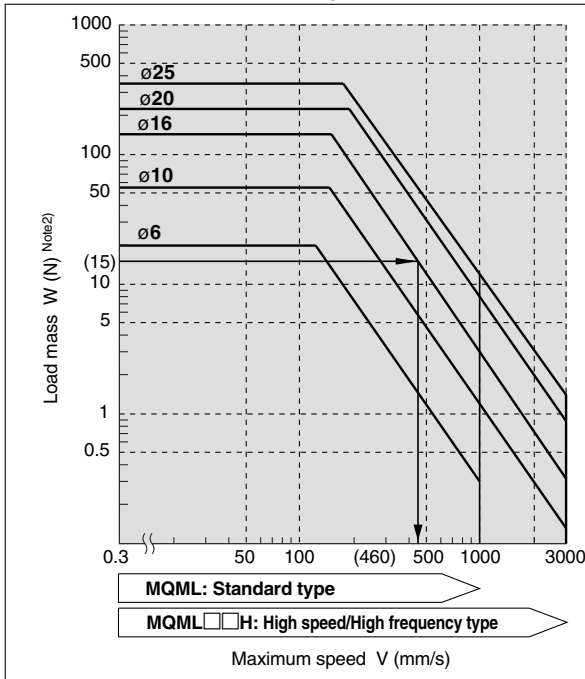

Example)  
Driving a load of 15(N) using the **MQM16** with a maximum speed of 460 (mm/sec)

#### Lateral load resisting type: MQML/MQML□□H

Bore size (mm)	Allowable kinetic energy (J)
6	0.015
10	0.059
16	0.161
20	0.386
25	0.597

Note 1) When a load is attached to the rod end, adjust the speed so that the maximum speed is no more than that shown in the graph for the corresponding load mass.

Note 2) The mass of cylinder's moving parts is included in the load mass. (See the graph on the right.)

### Moving Parts Mass

#### MQM Moving Parts Mass

Bore size (mm)	Moving parts mass (g)
6	Mass = 8.2 + {1.6 x (stroke/15)}
10	Mass = 12.0 + {1.6 x (stroke/15)}
16	Mass = 28.6 + {2.2 x (stroke/15)}
20	Mass = 72.0 + {6.4 x (stroke/15)}
25	Mass = 117.6 + {9.2 x (stroke/15)}

### Allowable Lateral Load at Rod End

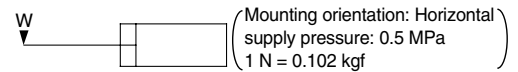

#### Allowable Lateral Load at Rod End

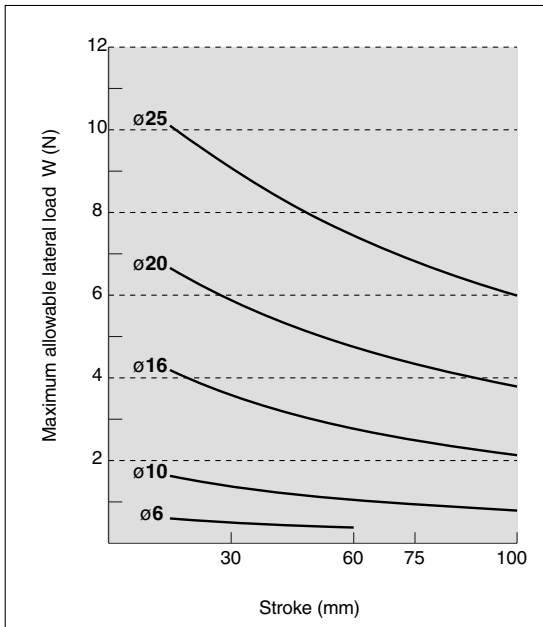

Note 1) The allowable lateral load varies depending on the size of a load (the distance to the load's center of gravity). Please contact SMC for further details.

REA

REB

REC

C□Y

C□X

**MQ**

RHC

RZQ

D-□

-X□

Individual  
-X□