

- Исполнения со встроенным и выносным дисплеем
- Гладкая внутренняя поверхность без подвижных частей обеспечивает устойчивость к пыли и засорению
- Малые потери давления (до 0.02 МПа)
- Компактный и легкий
- Функция обнаружения обратного потока у моделей со встроенным дисплеем
- Направление потока может быть изменено после установки
- Трехцветный дисплей с двумя экранами. Одновременная индикация мгновенного и установленного расхода
- Широкий диапазон измеряемого расхода (0.5 – 20 л/мин., 2.5 – 100 л/мин, 5 – 200 л/мин.)
- Малое время реакции. Высокая воспроизводимость.



Технические характеристики датчика с цифровой индикацией

Модель	LFE1	LFE2	LFE3
Рабочая среда	Вода или другие жидкости, не вызывающие коррозию контактирующих материалов (см. таблицу ниже)		
Электропроводимость жидкости	Не менее 5 мкСм/см		
Принцип действия датчика	Электромагнитный		
"Земля" источника питания ⁷⁾	Отрицательная		
Номинальный диапазон расхода (л/мин.)	0.5 ~ 20	2.5 ~ 100	5 ~ 200
Отображаемый и настраиваемый диапазон расхода (л/мин.)	0.4 ~ 24	2 ~ 120	4 ~ 240
Наименьшее измеряемое значение (л/мин.) ¹⁾	0.4	2	4
Наименьшая настраиваемая величина, л/мин	0.1	0.5	1
Цена импульса (л/импульс) (длительность импульса 50 мс)	0.1	0.5	1
Температура рабочей среды (°C) ²⁾	0 ~ 85 (не допускать замерзания и образования конденсата)		
Отображаемые параметры	Мгновенный расход (л/мин.), накопленный расход (л)		
Воспроизводимость	Отображение: ±2% полного диапазона ¹⁾ ; аналоговый выход: ±1.5% полного диапазона		
Влияние окружающей температуры и температуры среды (% от полного диапазона)	≤ ±5 в рабочем диапазоне температур по сравнению с измерением при 25°C		
Рабочее давление (МПа) ²⁾	0 ~ 1		
Испытательное давление (МПа) ²⁾	2		
Диапазон значений накопленного расхода (л)	0 ~ 99 999 999.9 по 0.1 л	0 ~ 999 999 999 по 1 л	
Дискретные выходы	Тип	PNP или NPN, открытый коллектор, макс. 28 VDC, макс. 80 mA	
	Внутр. падение напряжения	NPN: ≤ 1 В (при 80 mA) PNP: ≤ 1.5 В (при 80 mA)	
	Время реакции (с)	0.25, 0.5, 1, 2, 5	
	Защита выхода	От короткого замыкания	
	Режимы	Окно, гистерезис, реле накопленного расхода, импульсный выход для накопленного расхода (счетчик)	
Аналоговый выход	Время реакции (с)	0.25, 0.5, 1, 2, 5	
	По напряжению	1 ~ 5 В, выходной импеданс 1 кОм	
	Токовый	4 ~ 20 mA, макс. импеданс нагрузки 600 Ом	
Гистерезис	Регулируемый		
ЖК дисплей	2 экрана. Основной: 4 разряда, 7 сегментов, 2-цвета (красный/зеленый); подэкран: 6 разрядов, 11 сегментов, белый цвет; частота обновления 5 Гц		
Светодиодные индикаторы	Оранжевые: Выход 1 и Выход 2		
Напряжение питания	24 VDC ±10%		
Потребление тока (mA)	≤ 45 (без учета тока нагрузки)		
Степень защиты	IP65		
Температура окружающей среды (°C)	0 ~ 50 (не допускать замерзания и образования конденсата)		
Относительная влажность (%)	Рабочая и хранения: 35 ~ 85 (не допускать образования конденсата)		
Материалы, контактирующие со средой	PPS, FKM, C37		
Присоединение (G, Rc)	3/8	1/2	3/4
	340	400	520
Вес, базовое исполнение (г)	340		680

1) Расход ниже указанного отображается, как 0.

2) При работе с высокотемпературными средами максимальное рабочее давление снижается (см. график ниже)

3) По умолчанию датчик настроен таким образом, чтобы сбрасывать значение накопленного расхода при отключении питания. Функция F30 позволяет сохранять значение накопленного расхода в постоянной памяти каждые 2 или 5 минут. Максимальное количество циклов записи в память устройства составляет 1 млн. циклов.

Если устройство работает 24 часа в сутки, то ресурс памяти будет следующим: данные записываются каждые 5 минут (5 мин × 1 млн. циклов = 9,5 лет);

Данные записываются каждые 2 минуты (2 мин × 1 млн. циклов = 3,8 лет).

4) Время реакции должно примерно соответствовать времени, за которое расход достигает 63% заданного значения.

5) Возможна дополнительная задержка 0.05 с у времени срабатывания 0.25 с или 0.5 с, вызванная внутренними процессами в устройстве.

6) Стабильность отображения и аналогового выхода возрастает при увеличении времени реакции (см. график ниже)

7) Трубка и металлическая часть корпуса заземлены на DC(-) / синий провод. Датчик нельзя использовать, если в качестве земли использован (+).

Электромагнитный датчик расхода воды

LFE

Технические характеристики датчика с выносным дисплеем

Модель	LFE1	LFE2	LFE3	
Рабочая среда	Вода или другие жидкости, не вызывающие коррозию контактирующих материалов (см. таблицу ниже)			
Электропроводимость жидкости	Не менее 5 мкСм/см			
Принцип действия датчика	Электромагнитный			
"Земля" источника питания ³⁾	Отрицательная			
Номинальный диапазон расхода (л/мин.)	0.5 ~ 20	2.5 ~ 100	5 ~ 200	
Температура рабочей среды (°C) ¹⁾	0 ~ 85 (не допускать замерзания и образования конденсата)			
Воспроизводимость	Аналоговый выход: 1.5% полного диапазона			
Влияние окружающей температуры и температуры среды (% от полного диапазона)	≤ ±5 в рабочем диапазоне температур по сравнению с измерением при 25°C			
Рабочее давление (МПа) ¹⁾	0 ~ 1			
Испытательное давление (МПа) ¹⁾	2			
Аналоговый выход	Время реакции (с) ²⁾	0.5		
	По напряжению	1 ~ 5 В, выходной импеданс 1 кОм		
	Токовый	4 ~ 20 мА, макс. импеданс нагрузки 600 Ом		
Напряжение питания	24 VDC ±10%			
Потребление тока (мА)	≤ 45 (без учета тока нагрузки)			
Степень защиты	IP65			
Температура окружающей среды (°C)	0 ~ 50 (не допускать замерзания и образования конденсата)			
Относительная влажность (%)	Рабочая и хранения: 35 ~ 85 (не допускать образования конденсата)			
Материалы, контактирующие со средой	PPS, FKM, C37			
Присоединение (G, Rc)	3/8	1/2	3/4	1
Вес, базовое исполнение (г)	335	395	515	675

1) При работе с высокотемпературными средами максимальное рабочее давление снижается (см. график ниже)

2) Время реакции должно примерно соответствовать времени, за которое расход достигает 63% заданного значения

3) Трубка и металлическая часть корпуса заземлены на DC(-) / синий провод. Датчик нельзя использовать, если в качестве земли использован (+).

Совместимые рабочие среды

Жидкость	Примечание
Вода	водопроводная вода: 100 ~ 200 мкСм/см
СОЖ на водной основе	содержание воды не менее 50%

Приведенные данные носят справочный характер

Используйте жидкость с электрической проводимостью не менее 5мкСм/см.

Нельзя использовать расходомер для сред с низкой электрической проводимостью, таких как деионизированная вода, масла.

Ответная часть разъема M12 с кабелем

Проводник	Сечение	AWG21
	Наружный диаметр	Около 0,9 мм
Изоляция	Материал	Термостойкий ПВХ
	Наружный диаметр	Около 1.7 мм
	Цвет	Коричневый, белый, черный, синий
Наружная оболочка	Материал	Термостойкий бессвинцовый ПВХ
	Наружный диаметр кабеля	Ø6

Назначение контактов ответной части разъема:

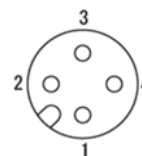

1	DC (+): коричневый
2	OUT2: белый
3	DC (-): синий
4	OUT1: черный

Аналоговый выход

Расход/Аналоговый выход

	A	B	C
По напряжению (В)	1	1,1	5
Токовый (мА)	4	4.4	20

Модель	Номинальный расход [л/мин.]	
	Минимальный	Максимальный
LFE1	0.5	20
LFE2	2.5	100
LFE3	5	200

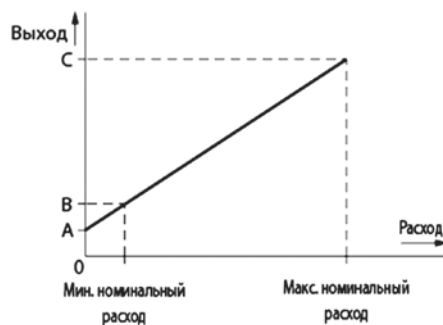

Рабочий диапазон давлений

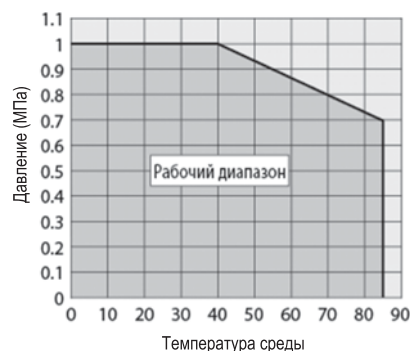

При повышении температуры среды максимальное рабочее давление снижается. Испытательное давление вдвое превышает рабочее давление.

Номер для заказа

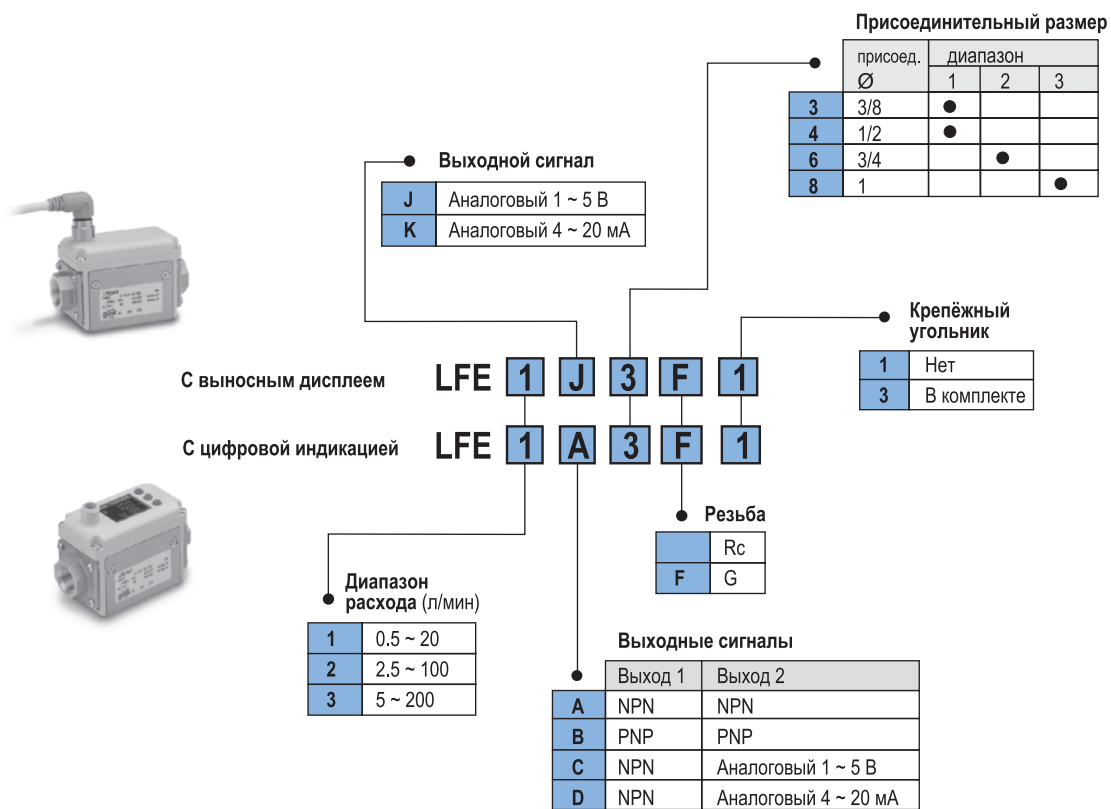

Принадлежности (заказываются отдельно)

Наименование	Номер для заказа	Вес (г)
Ответная часть разъема M12 с кабелем 3 м	LFE-1-A3	175

Контроллер для датчиков расхода воды

LFE0

- Совместим с датчиками расхода LFE□□, имеющими выходной сигнал 1 ~ 5 В

Технические характеристики

Серия		LFE0		
Номинальный и отображаемый диапазон расхода (л/мин)		0,4 ~ 24 Расход ниже 0,4 отображается как "0.00"	2 ~ 120 Расход ниже 2 отображается как "0.0"	4 ~ 240 Расход ниже 4 отображается как "0.0"
Наименьшая настраиваемая величина (л/мин)		0,1	0,5	1
Единица измерения накопл. расхода (л/импульс)		0,1	0,5	1
Единица отображения расхода		мгновенного: л/мин; накопленного: л		
Диапазон значений накопленного расхода (л) ¹⁾		0 ~ 99 999 999,9 (по 0,1 л)	0 ~ 999 999 999 (по 1 л)	
Точность отображения и аналогового выхода		± 0,5 % от полного диапазона		
Воспроизводимость		± 0,5 % от полного диапазона		
Влияние температуры		Не более ± 0,5 % от полного диапазона в рабочем диапазоне температур по сравнению с измерением при 25 °С		
Дискретный выход	Тип	PNP или NPN, открытый коллектор, макс. 28 VDC, макс. 80 mA		
	Внутр. падение напряжения	NPN: ≤ 1 В (при 80 mA); PNP: ≤ 1,5 В (при 80 mA)		
	Время реакции (с)	0,5, 1, 2, 5		
	Защита выхода	От короткого замыкания		
	Режимы	Окно, гистерезис, реле накопленного расхода, импульсный выход для накопленного расхода (счетчик)		
Аналоговый выход	Время реакции (с)	0,5, 1, 2, 5		
	Токовый	1 ~ 5 В, выходной импеданс 1 кОм		
	По напряжению	4 ~ 20 mA, макс. импеданс нагрузки 600 Ом		
Гистерезис		Регулируемый		
Вход / выход		Вход для копирования настроек		
ЖК дисплей		2 экрана. Основной: 4 разряда, 7 сегментов, 2 цвета (красный/зеленый); подэкран: 6 разрядов, 11 сегментов, белый цвет; частота обновления 5 Гц		
Светодиодные индикаторы		Оранжевые: Выход 1 и Выход 2		
Напряжение питания		24 VDC ±10%		
Потребление тока (mA)		≤ 50		
Электроподключение		Питание: 5-контактный разъем, подключение датчика: 4-контактный разъем e-conn		
Степень защиты		IP40 (IP65 у защитной передней панели)		
Температура окружающей среды (°C)		0 ~ 50 (не допускать замерзания и образования конденсата)		
Относительная влажность (%)		Рабочая и хранения: 35 ~ 85 (не допускать образования конденсата)		
Электрическая прочность изоляции		Устойчивость к воздействию испытательного напряжения 1000 VAC, приложенного в течение 1 мин. между токоведущими частями и корпусом		
Сопrotивление изоляции		Между токоведущими частями и корпусом ≥ 50 МОм (при 500 VDC)		
Вес (г)		50, с кабелем питания и выходных сигналов: 100		



1) По умолчанию датчик настроен таким образом, чтобы сбрасывать значение накопленного расхода при отключении питания. Можно сохранять значение накопленного расхода в постоянной памяти каждые 2 или 5 минут. Максимальное количество циклов записи в память устройства составляет 1 млн. циклов. Если устройство работает 24 часа в сутки, то ресурс памяти будет следующим:
Данные записываются каждые 5 минут: 5 мин × 1 млн. циклов = 5 млн. минут = 9,5 лет
Данные записываются каждые 2 минуты: 2 мин × 1 млн. циклов = 2 млн. минут = 3,8 лет.

Ответная часть разъема для подключения датчика

№ контакта	Назначение	Цвет провода кабеля датчика LFE□□
1	DC (+)	Коричневый
2	Не задействован / Вход	Не используется
3	DC (-)	Синий
4	Вход	Черный (сигнал 1 ~ 5 В датчика расхода)

Ответная часть разъема питания и выходных сигналов с кабелем

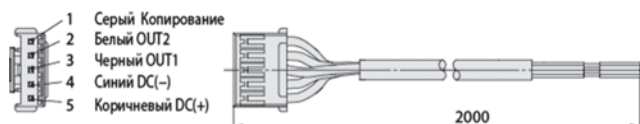

Номер для заказа

LFE0 **A** – M

Принадлежности (заказываются отдельно)

Наименование	Номер для заказа	Примечание
Ответная часть разъема с кабелем питания и выходных сигналов	ZS-40-W	Длина 2 м Входит в комплект поставки
Комплект для крепления на панели	ZS-26-B	Водонепроницаемое уплотнение и винты в комплекте
Комплект для крепления на панели + защитное стекло	ZS-26-C	
Защитное стекло	ZS-26-01	
Ответная часть разъема e-conn для подключения датчика	ZS-28-C-5	
Ответная часть разъема с кабелем копирования	ZS-40-Y	Можно подключать до 10 устройств "slave"

Выходы

	Выход 1	Выход 2
A	NPN	NPN
B	PNP	PNP
C	NPN	Аналоговый 1 ~ 5 В
D	NPN	Аналоговый 4 ~ 20 mA

New

3-color display Electromagnetic Type Digital Flow Switch



● Compact/Lightweight

● Weight: **340 g** (LFE1□3)

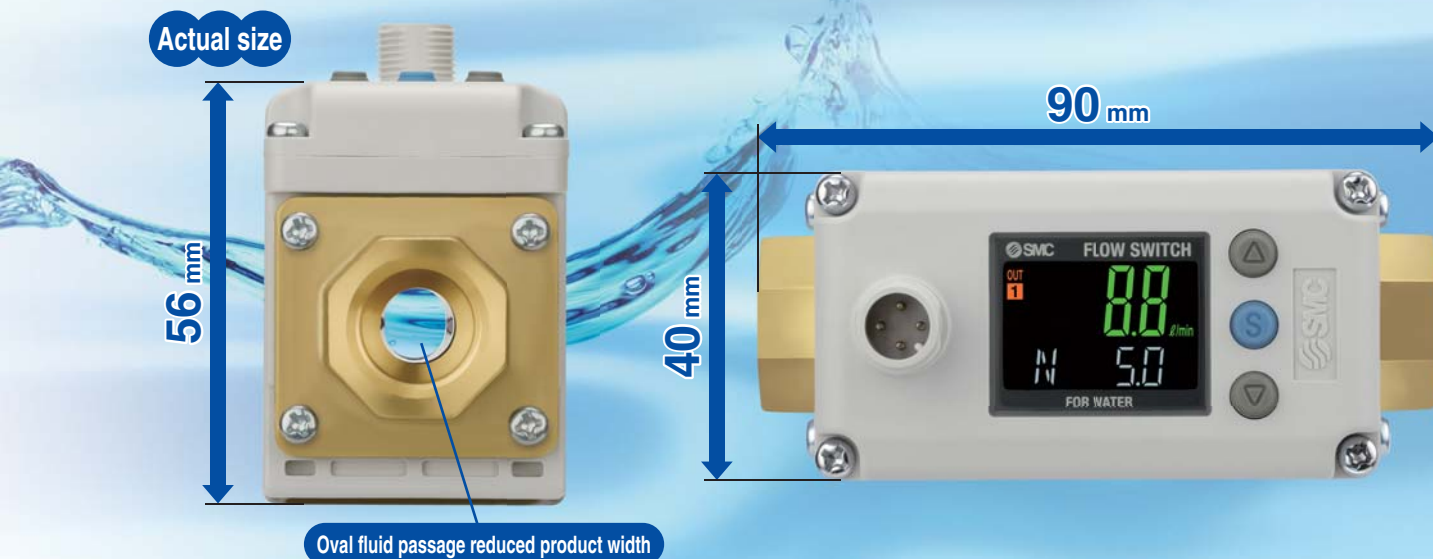

Oval fluid passage reduced product width

● Reverse flow can be detected.
Reverse flow error display

● Operating fluid temperature: **0 to 85°C**
(Refer to page 4.)

● Current consumption: **45 mA**
Reduced by up to 10% when the display is off.



Reverse flow error (Code LLL)

Reverse flow

Integrated display type



● Applicable fluids: Water, Water-soluble coolant
(Refer to page 18.)

Variations

Integrated display type/ Remote type	Flow range							
	0.5 L/min	2 L/min	5 L/min	10 L/min	20 L/min	50 L/min	100 L/min	200 L/min
LFE1	Rated flow range			Display flow range				
LFE2	Rated flow range				Display flow range			
LFE3	Display flow range	Rated flow range						

Remote type



Sensor unit

3-color display Monitor unit

Series **LFE** □



CAT.ES100-107B

● Pressure loss:
0.02 MPa or less



● Repeatability: **±1.5 % F.S.** (Analog output)

● Flow direction can be changed after installation. ● **3-color/2-screen display**

■ Default flow direction (Normal flow)



Parameters below can be set.

- Set value
- Flow direction
- Accumulated value
- Line name
- Peak/Bottom value

■ Flow direction can be changed after installation.

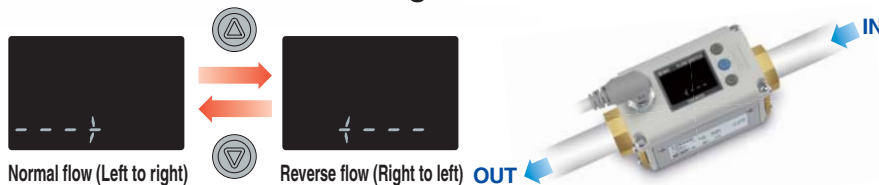

Application Examples

Flow control for pressurized cooling water for welding gun

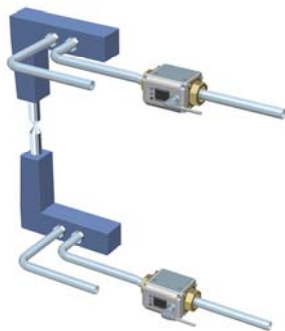

Flow control for water-soluble coolant

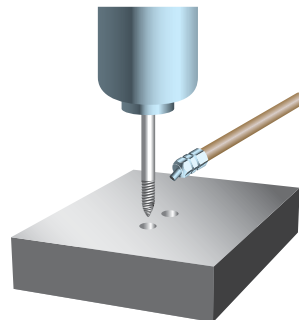

Flow control for cooling water for metal mold

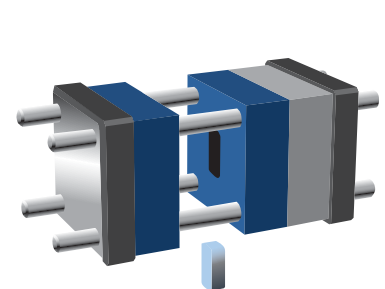

Principle

Faraday's law of induction

Measure the volume flow of inductive liquid by applying the Faraday's law of induction "when conductive object is moved through a magnetic field, electromotive force will be generated."



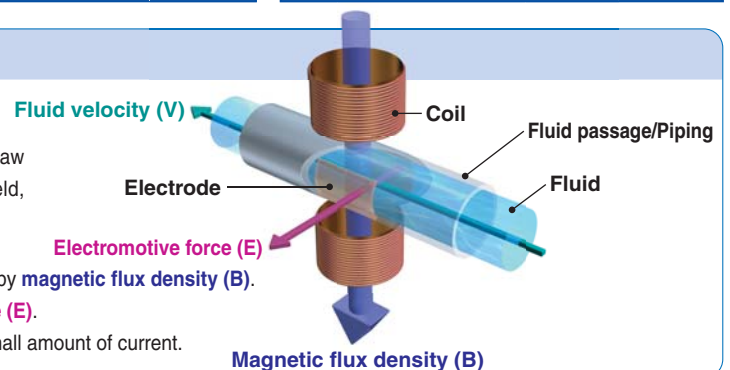

Electromotive force (E) is proportional to fluid velocity (V) multiplied by magnetic flux density (B).

Volume flow is calculated by converting measured electromotive force (E).

Oval fluid passage is used to improve the magnetic flux density by small amount of current.



Flow Switch for Liquid Variations

Series	Applicable fluid	Detection method	Minimum setting unit	Enclosure*	Display	Rated flow range [L/min]											
						0	0.5	2	5	10	20	30	40	50	100	150	200
LFE New 	Water/ Water-soluble coolant	Electromagnetic type	0.1 L/min	IP65	3-color display	0.5	[Bar chart: 0.5 to 20]					20					
			0.5 L/min			2.5	[Bar chart: 2.5 to 100]					100					
			1 L/min			5	[Bar chart: 5 to 200]					200					
PF3W 	Water/ Ethylene glycol aqueous solution	Karman vortex	0.01 L/min	IP65	3-color display	0.5	[Bar chart: 0.5 to 4]		4								
			0.1 L/min			2	[Bar chart: 2 to 16]		16								
			0.1 L/min			5	[Bar chart: 5 to 40]		40								
			1 L/min			10	[Bar chart: 10 to 100]		100								
			2 L/min			50	[Bar chart: 50 to 250]		250								
PVC piping type 	Water/ Ethylene glycol aqueous solution	Karman vortex	1 L/min	IP65	3-color display	10	[Bar chart: 10 to 100]		100								
			2 L/min			30	[Bar chart: 30 to 250]		250								
PF2D 	Deionized water and Chemicals	Karman vortex	0.05 L/min	IP65	1-color display	0.4	[Bar chart: 0.4 to 4]		4								
			0.1 L/min			1.8	[Bar chart: 1.8 to 20]		20								
			0.5 L/min			4	[Bar chart: 4 to 40]		40								

* For remote type monitor unit, only the front side is IP65 compliant. Other parts are IP40 compliant.

INDEX

3-Color Display Electromagnetic Type Digital Flow Switch Series LFE

How to Order	P.1
Specifications (Integrated Display Type)	P.2
Specifications (Remote Type Sensor Unit)	P.3
Flow-rate Characteristics (Pressure Loss)	P.4
Internal Circuits and Wiring Examples	P.5
Parts Description	P.6
Dimensions	P.7

3-Color Display Digital Flow Monitor Series LFE0

How to Order	P.8
Specifications	P.9
Internal Circuits and Wiring Examples	P.10
Parts Description (Remote Type Monitor Unit)	P.11
Dimensions	P.12

Function Details	P.13
Specific Product Precautions	P.16

3-color display

Electromagnetic Type Digital Flow Switch

Series LFE



RoHS

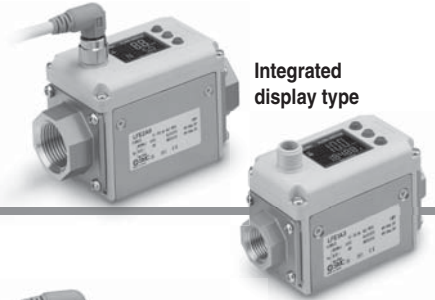

Integrated display type



Remote type sensor unit



Remote type monitor unit
(For details, refer to page 8.)

How to Order

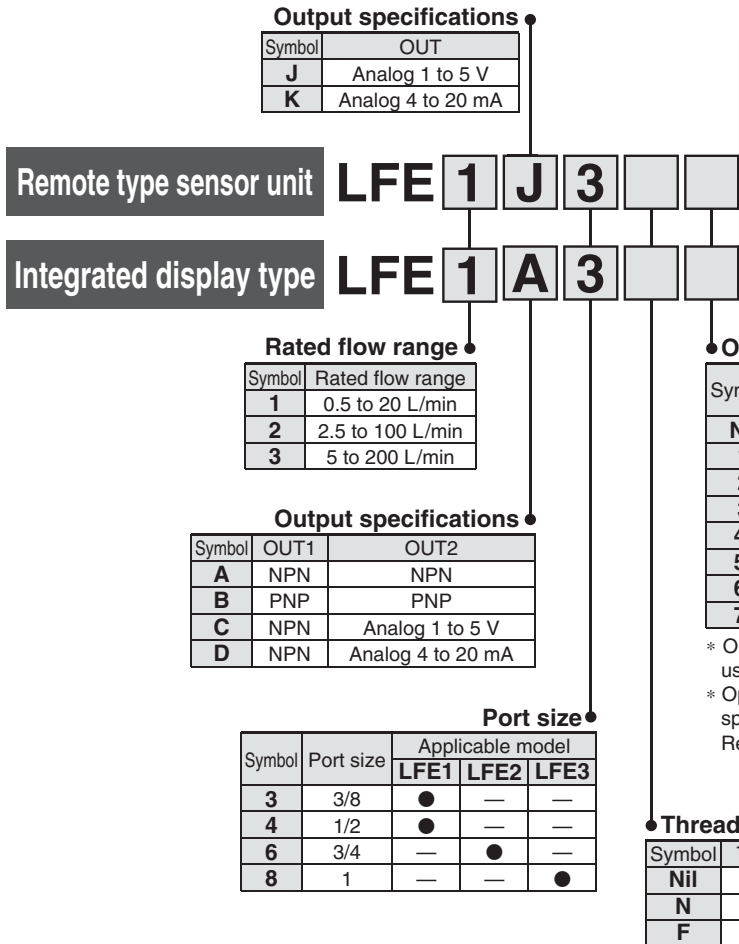

Option/Part No.

When only optional parts are required, order with the part number listed below.

Option	Part no.	Note	Weight
Lead wire with M12 connector	LFE-1-A3	Lead wire length 3 m	Approx. 175 g

Option	Part no.	Note	Weight
Bracket	LFE-1-D	Tapping screw for LFE1 (3 x 10), 4 pcs.	Approx. 45 g
	LFE-2-D	Tapping screw for LFE2 (3 x 10), 4 pcs.	Approx. 70 g
	LFE-3-D	Tapping screw for LFE3 (3 x 10), 4 pcs.	Approx. 70 g

Specifications (Integrated Display Type)

Model		LFE1	LFE2	LFE3
Applicable fluid <small>Note 1)</small>		Water, Conductive fluids which do not corrode the fluid contact materials. <small>Note 1)</small>		
Applicable fluid conductivity <small>Note 1)</small>		5 μ S/cm or more (micro siemens)		
Detection method		Electrostatic capacity type		
Ground <small>Note 10)</small>		Negative ground		
Rated flow range		0.5 to 20 L/min	2.5 to 100 L/min	5 to 200 L/min
Display flow range		0.4 to 24.0 L/min	2.0 to 120.0 L/min	4 to 240 L/min
Set flow range		0.4 to 24.0 L/min	2.0 to 120.0 L/min	4 to 240 L/min
Zero-cut flow <small>Note 2)</small>		0.4 L/min	2.0 L/min	4 L/min
Minimum setting unit		0.1 L/min	0.5 L/min	1 L/min
Accumulated volume per pulse (Pulse width: 50 ms)		0.1 L/pulse	0.5 L/pulse	1 L/pulse
Operating fluid temperature <small>Note 3)</small>		0 to 85°C (with no freezing and condensation)		
Display units		Instantaneous flow rate L/min, Accumulated flow L		
Repeatability		Displayed values: \pm 2% F.S. Analog output: \pm 1.5% F.S.		
Temperature characteristics	Ambient temperature	\pm 5% F.S. (25°C reference)		
	Fluid temperature	\pm 5% F.S. (25°C reference)		
Operating pressure range <small>Note 3)</small>		0 to 1 MPa		
Proof pressure <small>Note 3)</small>		2 MPa		
Accumulated flow range <small>Note 4)</small>		99999999.9 L by 0.1 L	99999999.9 L by 1 L	
Switch output		NPN or PNP open collector output		
	Maximum load current	80 mA		
	Maximum applied voltage	28 VDC		
	Internal voltage drop	NPN: 1 V or less (at load current 80 mA) PNP: 1.5 V or less (at load current 80 mA)		
	Response time <small>Note 5) 7)</small>	0.25 s/0.5 s/1 s/2 s/5 s		
	Output protection	Short-circuit protection		
	Output mode	Select from hysteresis mode, window comparator mode, accumulated output mode, or accumulated pulse output mode.		
Analog output	Response time <small>Note 6) 7)</small>	0.25 s/0.5 s/1 s/2 s/5 s		
	Voltage output	Output voltage: 1 to 5 V Output impedance: 1 k Ω		
	Current output	Output current: 4 to 20 mA Max. load impedance: 600 Ω		
Hysteresis		Variable		
Display method		2-screen (Main screen: 4-digit, 7-segment, 2-color, Red/Green; Sub screen: 6-digit, 11-segment, White) Display values updated 5 times per second		
Status LED's		Output 1, Output 2: (Orange)		
Power supply voltage		24 VDC \pm 10%		
Current consumption		45 mA or less (Load current is not included.)		
Environmental resistance	Enclosure <small>Note 9)</small>	IP65		
	Operating temperature range	0 to 50°C (with no freezing and condensation)		
	Operating humidity range	Operating, Storage: 35 to 85% R.H. (with no condensation)		
Standards and regulations		CE marking, RoHS		
Parts material in contact with fluid		PPS, FKM, C37		
Port size		3/8 (10A)	1/2 (15A)	3/4 (20A) 1 (25A)
Weight (Body) <small>Note 8)</small>		Approx. 340 g	Approx. 400 g	Approx. 520 g 680 g

Note 1) Refer to "Applicable Fluids List" on page 18.

Note 2) 0 L/min is displayed when the flow is less than zero-cut flow.

Note 3) When fluids with high temperature are used, the operating pressure range and proof pressure will be reduced. (For details, refer to "Operating Pressure Range" on page 4.)

Note 4) Cleared when the power supply is turned off. Hold function can be selected. (Interval of 2 or 5 minutes can be selected.) If the 5 minutes interval is selected, the life of the memory element (electronic parts) is limited to 1 million cycles. (If energized for 24 hours, life is calculated as 5 minutes x 1 million = 5 million minutes = about 9.5 years.) Therefore, if using the hold function, calculate the memory life for your operating conditions, and use within this life.

Note 5) The response time when the set value is 63% in relation to the step input.

Note 6) The response time until the set value reaches 63% in relation to the step input. There might be a 0.05 seconds delay at response time of 0.25 s or 0.5 s due to the timing of internal processing.

Note 7) The stability of display and analog output is improved by increasing the response time setting. (For details, refer to "Stability" on page 4.)

Note 8) When options are used, add the weight of the optional parts.

Note 9) Enclosure is for digital flow switch with lead wire and M12 connector.

Note 10) Piping port is grounded to DC(-)/blue line. Power supply with positive ground cannot be used. Please consult SMC if the product is used for positive ground environment.

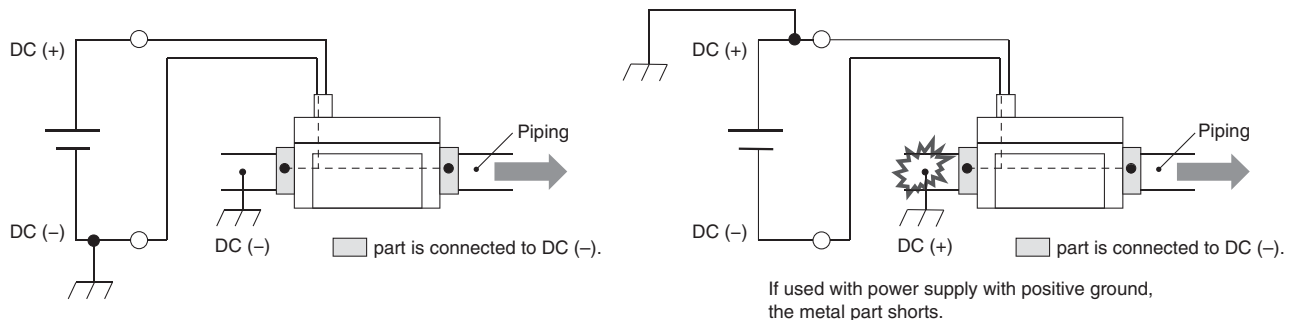

Specifications (Remote Type Sensor Unit)

Refer to page 9 for the monitor unit specifications.

Model	LFE1	LFE2	LFE3
Applicable fluid <small>Note 1)</small>	Water, Conductive fluids which do not corrode the fluid contact materials. <small>Note 1)</small>		
Applicable fluid conductivity <small>Note 1)</small>	5 μ S/cm or more (micro siemens)		
Detection method	Electrostatic capacity type		
Ground <small>Note 5)</small>	Negative ground		
Rated flow range	0.5 to 20 L/min	2.5 to 100 L/min	5 to 200 L/min
Operating fluid temperature <small>Note 2)</small>	0 to 85°C (with no freezing and condensation)		
Repeatability	Analog output: \pm 1.5% F.S.		
Temperature characteristics	Ambient temperature	\pm 5% F.S. (25°C reference)	
	Fluid temperature	\pm 5% F.S. (25°C reference)	
Operating pressure range <small>Note 2)</small>	0 to 1 MPa		
Proof pressure <small>Note 2)</small>	2 MPa		
Analog output	Response time <small>Note 3)</small>	0.5 s	
	Voltage output	Output voltage: 1 to 5 V Output impedance: 1 k Ω	
	Current output	Output current: 4 to 20 mA Max. load impedance: 600 Ω	
Power supply voltage	24 VDC \pm 10%		
Current consumption	42 mA or less (Load current is not included.)		
Environmental resistance	Enclosure	IP65	
	Operating temperature range	0 to 50°C (with no freezing and condensation)	
	Operating humidity range	Operating, Storage: 35 to 85% R.H. (with no condensation)	
Standards and regulations	CE marking, RoHS		
Parts material in contact with fluid	PPS, FKM, C37		
Port size	3/8 (10A)	1/2 (15A)	3/4 (20A)
Weight (Body) <small>Note 4)</small>	Approx. 335 g	Approx. 395 g	Approx. 515 g

Note 1) Refer to "Applicable Fluids List" on page 18.

Note 2) When fluids with high temperature are used, the available pressure range will be reduced. (For details, refer to "Operating Pressure Range" on page 4.)

Note 3) The response time until the set value reaches 63% in relation to the step input.

Note 4) When options are used, add the weight of the optional parts.

Note 5) Piping port and the metal part of the body are grounded to DC(-)/blue line. Power supply with positive ground cannot be used. Please consult SMC if the product is used for positive ground environment.

Analog Output

Flow/Analog output

	A	B	C
Voltage output	1 V	1.1 V	5 V
Current output	4 mA	4.4 mA	20 mA

Model	Rated flow [L/min]	
	Minimum	Maximum
LFE1	0.5	20
LFE2	2.5	100
LFE3	5	200

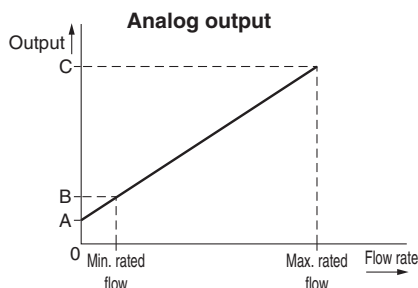

Flow-rate Characteristics (Pressure Loss)

LFE1

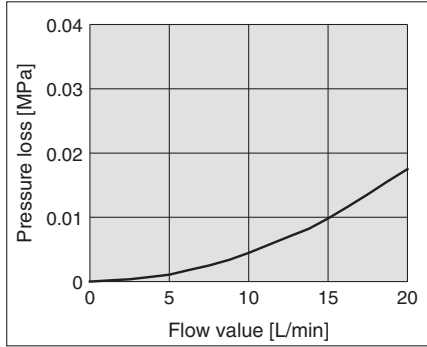

LFE2

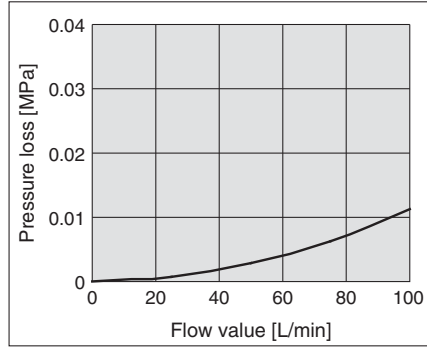

LFE3

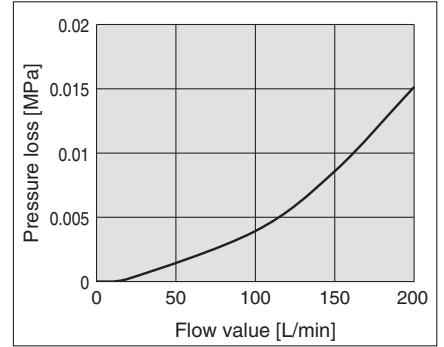

Straight Piping Length and Accuracy (Reference Value)

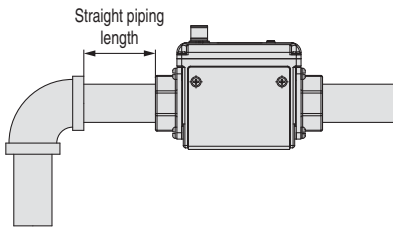

[Measurement conditions]

Fluid: Tap water
Pressure: 0.2 MPa

[Port size]

LFE1: 3/8 inch
LFE2: 3/4 inch
LFE3: 1 inch

Accuracy change

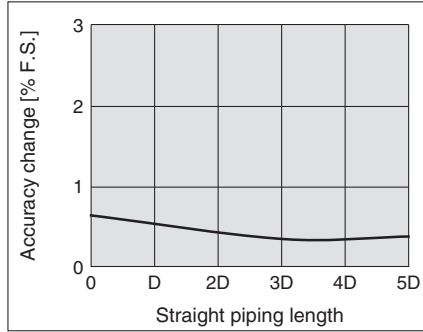

- The smaller the piping size, the more the product is affected by the straight piping length. The straight piping length shall be 5 times (5D) or more of the piping size to achieve the stable measurement.

Model	Straight piping length (mm)	
	D	5D
LFE1	11	55
LFE2	21	105
LFE3	27	135

Stability

- * Stability is improved by increasing the response time setting.
- * Stability indicates the fluctuation width of the display or analog output.

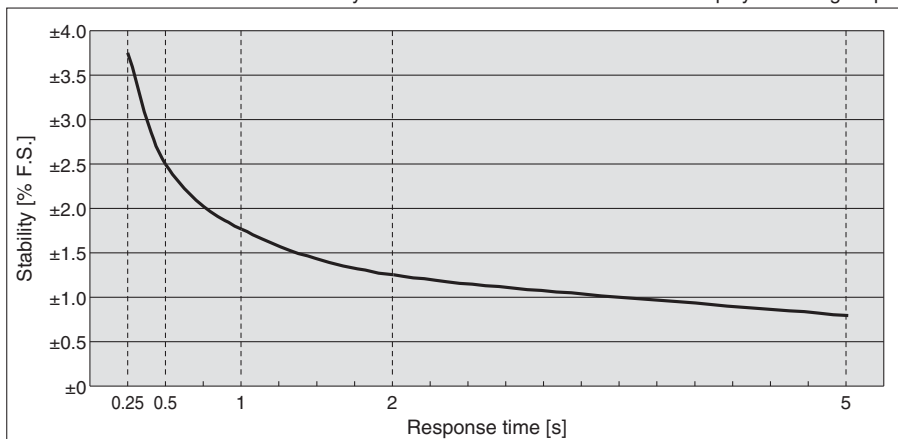

Operating Pressure Range

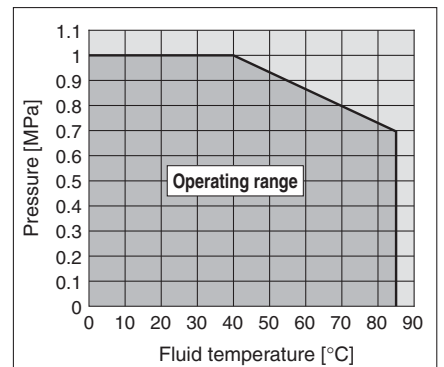

When fluids with high temperature are used, the operating pressure range will be reduced. Operate within the range mentioned above. The proof pressure is double the operating pressure range.

Series LFE

Internal Circuits and Wiring Examples (Integrated Display Type)

NPN 2 outputs type LFE□A□□□

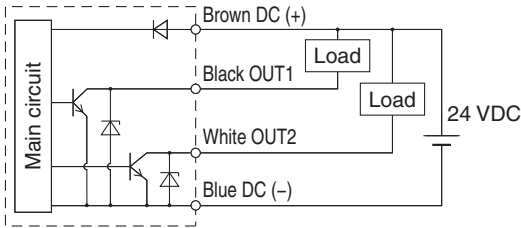

Max. 28 V, 80 mA
Internal voltage drop 1 V or less

PNP 2 outputs type LFE□B□□□

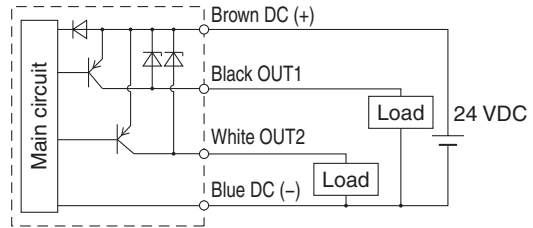

Max. 80 mA
Internal voltage drop 1.5 V or less

NPN + Analog output type LFE□C□□□

NPN + Analog output type LFE□D□□□

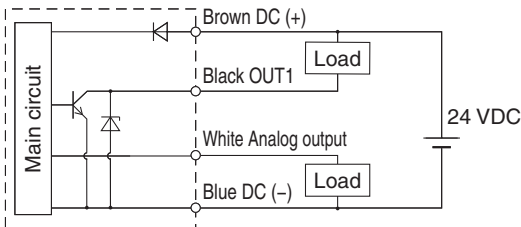

Max. 28 V, 80 mA
Internal voltage drop 1 V or less
C: Analog output 1 to 5 V
Output impedance 1 kΩ
D: Analog output 4 to 20 mA
Load impedance 50 to 600 Ω

Accumulated pulse output wiring examples

NPN 2 outputs type LFE□A□□□

NPN + Analog output type LFE□C□□□/ LFE□D□□□

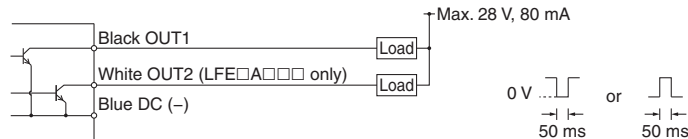

PNP 2 outputs type LFE□B□□□

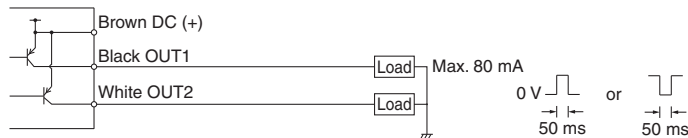

* When accumulated pulse output is selected, the indicator light is turned off.

Internal Circuits and Wiring Examples (Remote Type Sensor Unit)

Analog output type

LFE□J□□□ (Voltage output type) LFE□K□□□ (Current output type)

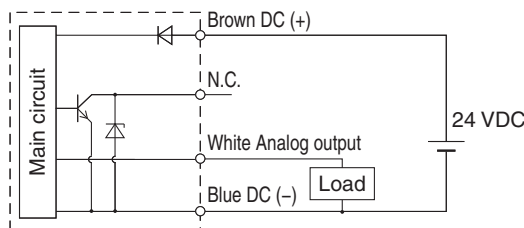

* Do not connect N.C.

Parts Description

Body

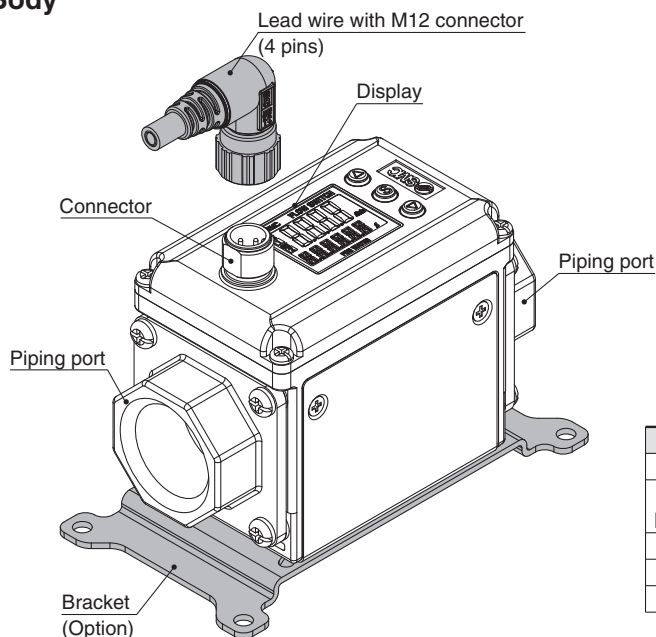

Description	Function
Connector	M12 connector for electrical connections
Lead wire with M12 connector	Cable for supplying power to the product and for receiving output
Piping port	For piping connections
Display	Displays the flow, set values and error information.
Bracket	Mounting bracket for installing the product

Display

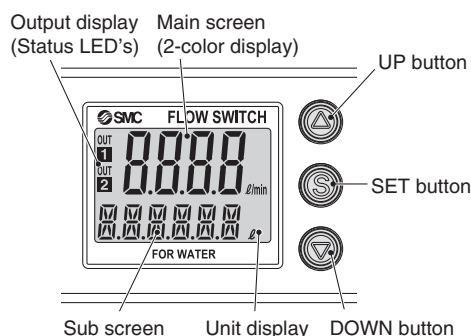

Description	Function
Main screen (2-color display)	Displays the flow value, setting mode and error codes.
Sub screen	Displays the accumulated flow, set value, peak/bottom value, flow direction and line names. In setting mode, the set status is displayed. (For details, refer to page 13.)
Output display (Status LED's)	Displays the output condition of OUT1 and OUT2. When ON: Orange light turns on.
UP button	Selects the mode and the display shown on the sub screen, or increases the ON/OFF set value.
SET button	Used to make changes in each mode and to enter the set value.
DOWN button	Selects the mode and the display shown on the sub screen, or decreases the ON/OFF set value.
Unit display	Indicates the unit currently selected.

Fluid Passage Structure

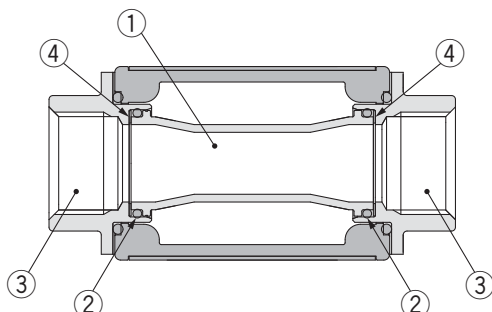

No.	Description	Material
1	Pipe	PPS
2	O-ring	FKM
3	Attachment	C37
4	Spacer	FKM

Series LFE

Dimensions

Integrated display type LFE1/2/3

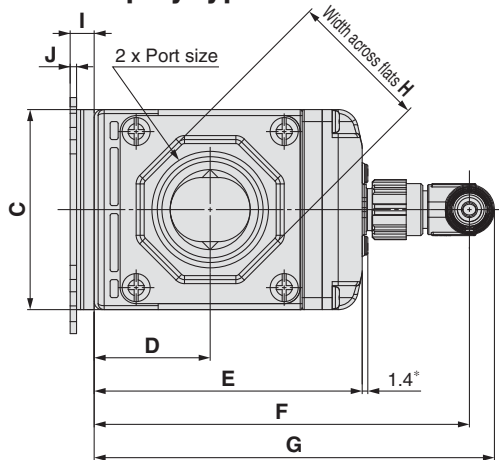

* For integrated display type

Note) The electrical entry for lead wire with M12 connector does not rotate and is limited to only one entry direction.

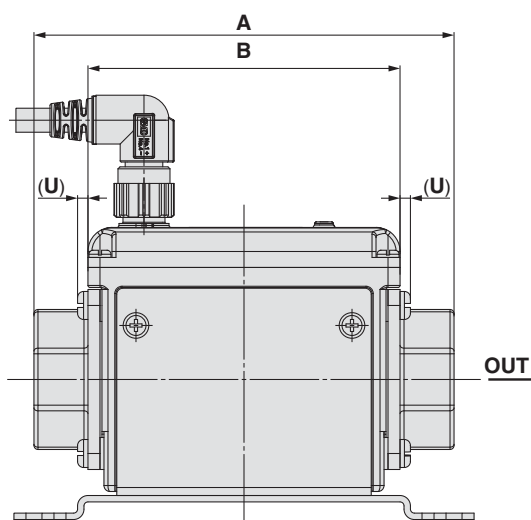
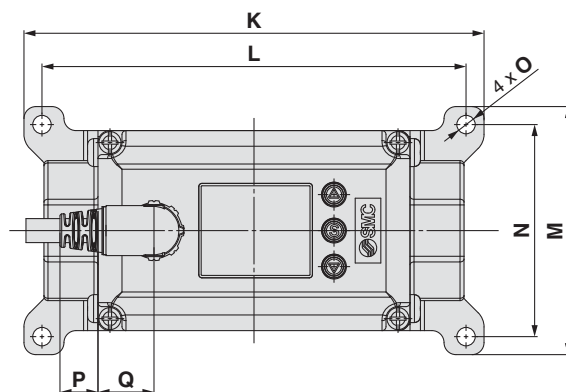

Bracket thickness is approx. 1.6 mm.

Remote type sensor unit LFE1/2/3

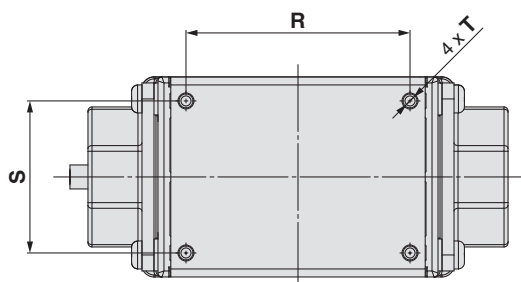
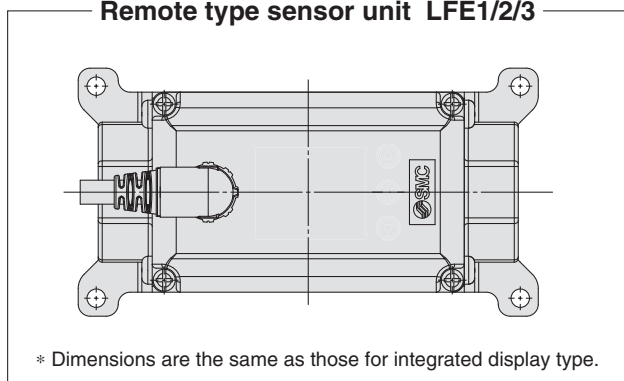

Without bracket (Bottom view)

Model	Port size	A	B	C	D	E	F	G	H	I	J	K	L	M	N	O	P	Q	R	S	T	U
LFE1□3□	3/8	90	73	40	23.5	56	83	89	24	6	1.6	96	87	48	39	4.6	12	11.5	52	28	ø2.5 depth 8.5	2
LFE1□4□	1/2	104	73	40	23.5	56	83	89	28	6	1.6	96	87	48	39	4.6	12	11.5	52	28	ø2.5 depth 8.5	2
LFE2□	3/4	105	78	50	29	67	94	100	35	6	1.6	115	106	62	53	4.6	9.5	14	56	38	ø2.5 depth 8.5	2.6
LFE3□	1	120	90	55	32	73	100	106	41	6	1.6	115	106	62	53	4.6	3.5	20	68	43	ø2.5 depth 8.5	2.6

Note) If you are installing directly, choose the self tapping screw screw-in depth is to 8 mm. Tighten the screw with a torque of 0.7 to 0.8 N-m.

Lead wire with M12 connector

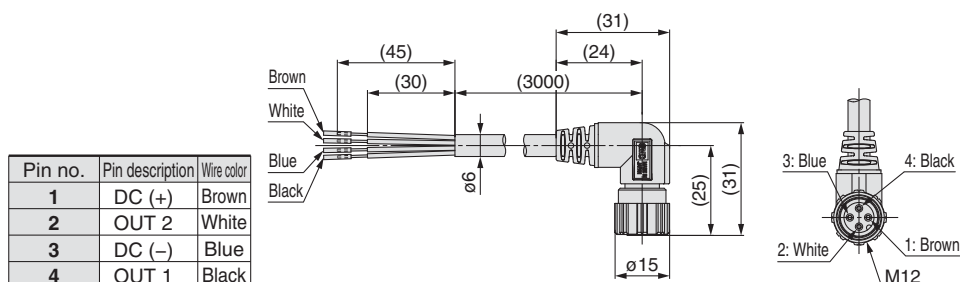

Cable Specifications

Conductor	Nominal cross section area	AWG21
	External diameter	Approx. 0.9 mm
Insulator	Material	Non-lead heat resistant PVC
	External diameter	Approx. 1.7 mm
Sheath	Colors	Brown, White, Black, Blue
	Material	Non-lead heat and oil resistant PVC
Finished external diameter		ø6

3-color display

Digital Flow Monitor Series LFE0



How to Order

LFE0 **A** - **M** **V** **C**

Type

0 Remote type monitor unit
For remote type sensor unit, select the analog output 1 to 5 V type.
Applicable sensors: LFE□J□□□

Output specifications

Symbol	OUT1	OUT2
A	NPN	NPN
B	PNP	PNP
C	NPN	Analog 1 to 5 V
D	NPN	Analog 4 to 20 mA

Lead wire

Nil	With power supply/output connection lead wire (2 m) Power supply/output connection lead wire ZS-40-W
N	Without power supply/output connection lead wire Lead wire is not connected, but shipped together.

Remote type monitor unit/Unit specifications

Symbol	Instantaneous flow rate	Accumulated flow
M	L/min	L
G	gal/min	gal

* Under the New Measurement Law, units other than SI (symbol "M") cannot be used in Japan.
Note) G: Made to Order
Reference: 1 [L/min] ↔ 0.2642 [gal/min]
1 [gal/min] ↔ 3.785 [L/min]

Option 2

Nil	Without connector Sensor connector (1 pc.)
C	 Sensor connector (e-con) Connector is not connected, but shipped together.

Option 1

Nil	None
T	Panel mount adapter Waterproof seal (Accessory) Panel mount adapter Mounting screw (M3 x 8L) (Accessory) Panel
V	Front protective cover + Panel mount adapter Front protective cover Waterproof seal (Accessory) Panel mount adapter Mounting screw (M3 x 8L) (Accessory) Panel

Option/Part No.

When only optional parts are required, order with the part numbers listed below.

Description	Part no.	Note
Panel mount adapter	ZS-26-B	With waterproof seal, mounting screw
Front protective cover + Panel mount adapter	ZS-26-C	With waterproof seal, mounting screw
Front protective cover only	ZS-26-01	Separately order panel mount adapter etc.
Power supply/output connection lead wire	ZS-40-W	Lead wire length 2 m
Sensor connector (e-con)	ZS-28-C-5	1 pc.
Lead wire with connector for copying	ZS-40-Y	Connect up to 10 slave units

Series LFE0

Specifications

Model		LFE0		
Display flow range	0.4 to 24.0 L/min (Flow under 0.4 L/min is displayed as "0.00")	2.0 to 120.0 L/min (Flow under 2.0 L/min is displayed as "0.0")	4 to 240 L/min (Flow under 4 L/min is displayed as "0.0")	
Set flow range	0.4 to 24.0 L/min	2.0 to 120.0 L/min	4 to 240 L/min	
Minimum setting unit	0.1 L/min	0.5 L/min	1 L/min	
Accumulated volume per pulse	0.1 L/pulse	0.5 L/pulse	1 L/pulse	
Display units	Instantaneous flow rate L/min, Accumulated flow L			
Accuracy	Displayed values: $\pm 0.5\%$ F.S., Analog output: $\pm 0.5\%$ F.S.			
Repeatability	$\pm 0.5\%$ F.S.			
Temperature characteristics	$\pm 0.5\%$ F.S. (25°C reference)			
Accumulated flow range <small>Note 1)</small>	9999999.9 L by 0.1 L	99999999 L by 1 L		
Switch output	NPN or PNP open collector output			
Maximum load current	80 mA			
Maximum applied voltage	28 VDC			
Internal voltage drop	NPN: 1 V or less (at load current 80 mA) PNP: 1.5 V or less (at load current 80 mA)			
Response time <small>Note 2)</small>	0.5 s/1 s/2 s/5 s			
Output protection	Short-circuit protection			
Output mode	Select from hysteresis mode, window comparator mode, accumulated output mode, or accumulated pulse output mode.			
Flow rate mode	Select from hysteresis mode or window comparator mode.			
Response time <small>Note 3)</small>	0.5 s/1 s/2 s/5 s (linked with the switch output)			
Voltage output	Output voltage: 1 to 5 V Output impedance: 1 k Ω			
Current output	Output current: 4 to 20 mA Max. load impedance: 300 Ω for 12 VDC, 600 Ω for 24 VDC			
Hysteresis	Variable			
Input/output	Input for copy mode			
Display method	2-screen (Main screen: 4-digit, 7-segment, 2-color, Red/Green; Sub screen: 6-digit, 11-segment, White) Display values updated 5 times per second			
Status LED's	Output 1, Output 2: (Orange)			
Power supply voltage	24 VDC $\pm 10\%$			
Current consumption	50 mA or less			
Connection	Power supply output 5P connector, sensor connection 4P connector (e-con)			
Environmental resistance	Enclosure	IP40 (Only front face of the panel is IP65 when panel mount adapter and waterproof seal of optional parts are used.)		
	Operating temperature range	0 to 50°C (with no freezing and condensation)		
	Operating humidity range	Operating, Storage: 35 to 85% R.H. (with no condensation)		
	Withstand voltage	1000 VAC for 1 minute between terminals and housing		
Standards and regulations	Insulation resistance 50 M Ω or more (500 VDC measured via megohmmeter) between terminals and housing CE marking, RoHS			
Weight	Without power supply/output connection lead wire	50 g		
	With power supply/output connection lead wire	100 g		

Note 1) Cleared when the power supply is turned off. Hold function can be selected. (Interval of 2 or 5 minutes can be selected.) If the 5 minutes interval is selected, the life of the memory element (electronic parts) is limited to 1 million cycles. (If energized for 24 hours, life is calculated as 5 minutes x 1 million = 5 million minutes = about 9.5 years.) Therefore, if using the hold function, calculate the memory life for your operating conditions, and use within this life.

Note 2) The response time when the set value is 63% in relation to the step input.

Note 3) The response time until the set value reaches 63% in relation to the step input.

Analog Output

Flow/Analog output

	A	B	C
Voltage output	1 V	1.1 V	5 V
Current output	4 mA	4.4 mA	20 mA

Connected sensor	Rated flow [L/min]	
	Minimum	Maximum
LFE1	0.5	20
LFE2	2.5	100
LFE3	5	200

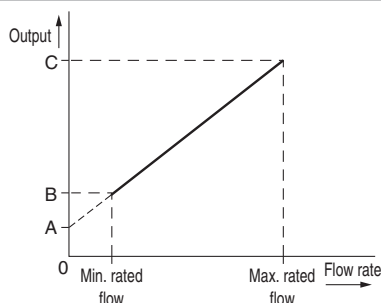

Internal Circuits and Wiring Examples

NPN 2 outputs type LFE0A

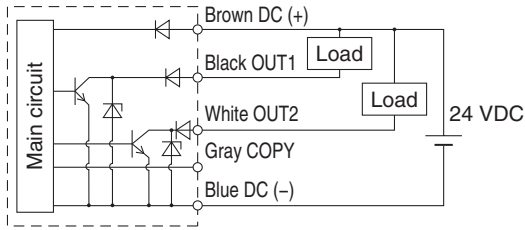

PNP 2 outputs type LFE0B

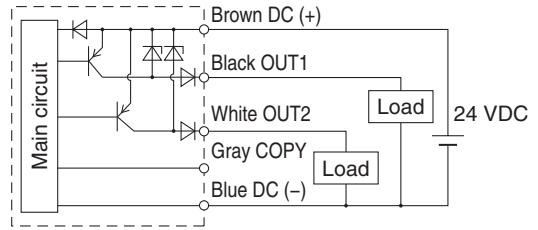

NPN + Analog output type LFE0C

NPN + Analog output type LFE0D

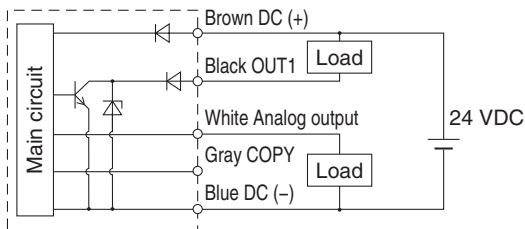

Sensor input circuit

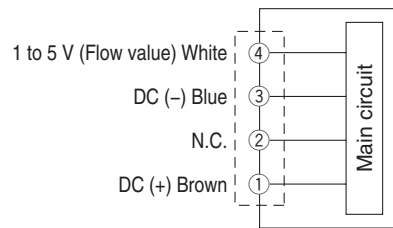

* Do not connect N.C.

Accumulated pulse output wiring examples

NPN 2 outputs type LFE0A

NPN + Analog output type LFE0C/LFE0D

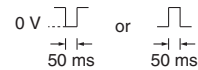
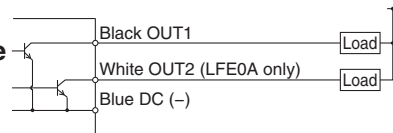

PNP 2 outputs type LFE0B

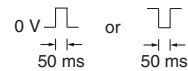
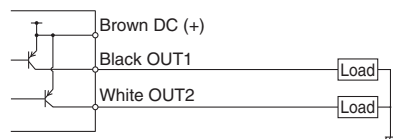

* When accumulated pulse output is selected, the indicator light is turned off.

Series LFE0

Parts Description (Remote Type Monitor Unit)

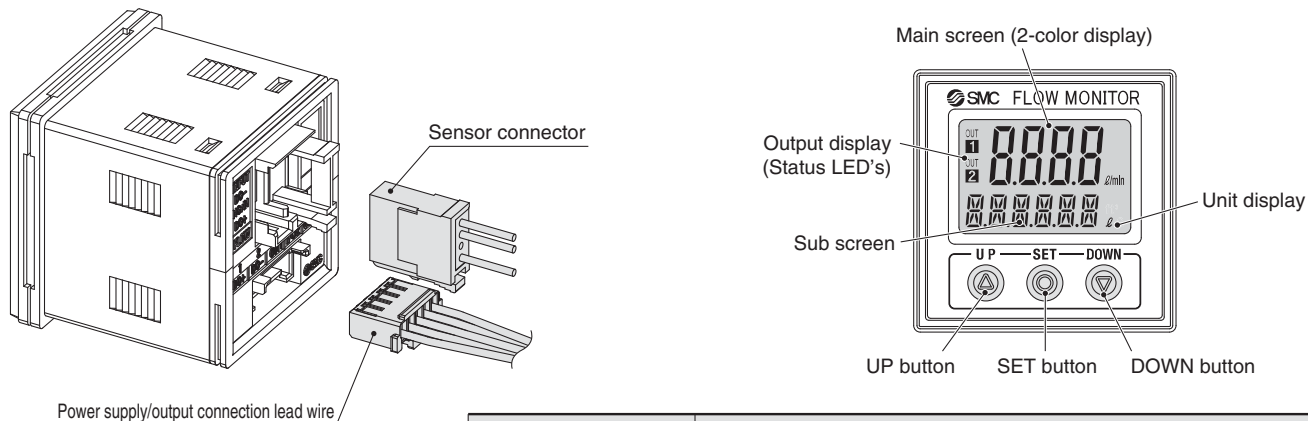

Description	Function
Main screen (2-color display)	Displays the flow value, setting mode and error codes.
Sub screen	Displays the accumulated flow, set value, peak/bottom value, fluid temperature and line names. In the setting mode, the set status is displayed. (For details, refer to page 13.)
Output display (Status LED's)	Displays the output condition of OUT1 and OUT2. When ON: Orange light turns on.
Unit display	Indicates the unit currently selected.
UP button	Selects the mode and the display shown on the sub screen, or increases the ON/OFF set value.
SET button	Press this button to change the mode and to set a value.
DOWN button	Selects the mode and the display shown on the sub screen, or decreases the ON/OFF set value.

Sensor connector

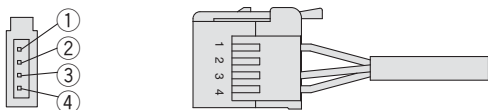

Pin no.	Terminal	Connector no.	Lead wire color *
①	DC (+)	1	Brown
②	N.C./IN	2	Not used
③	DC (-)	3	Blue
④	INPUT	4	White (Temperature sensor 1 to 5 V input)

* When using the lead wire with M12 connector included with the LFE□J series.
Do not connect black.

Power supply/output connection lead wire

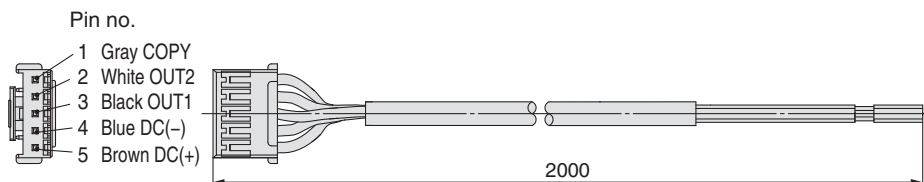

Cable Specifications

Conductor	Nominal cross section area	AWG26
	External diameter	Approx. 0.5 mm
Insulator	Material	Cross-linked vinyl
	External diameter	Approx. 1.0 mm
	Colors	Brown, Blue, Black, White, Gray
Sheath	Material	Oil and heat resistant vinyl
	Finished external diameter	ø3.5

Dimensions

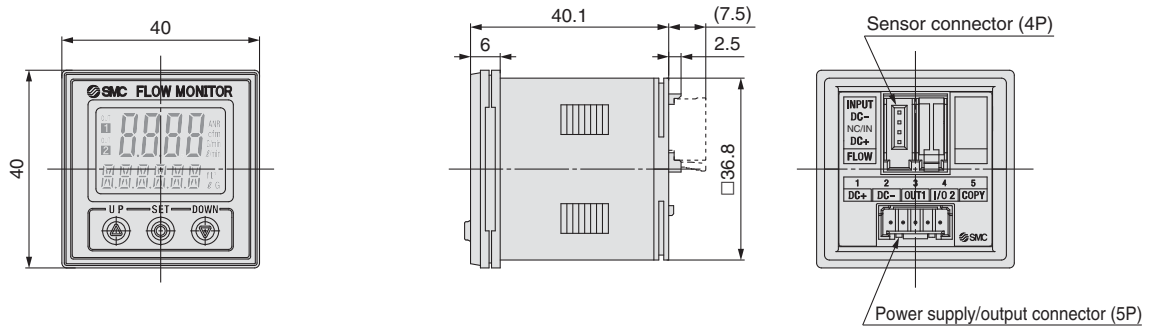

Front protective cover + Panel mount adapter

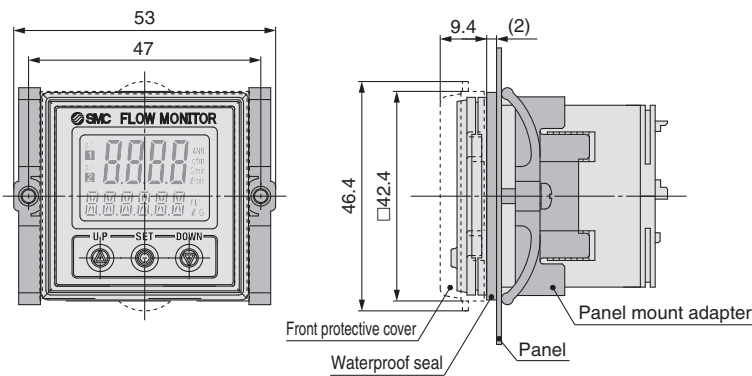

Panel fitting dimensions

Applicable panel thickness:
 0.5 to 8 mm (Without waterproof seal)
 0.5 to 6 mm (With waterproof seal)

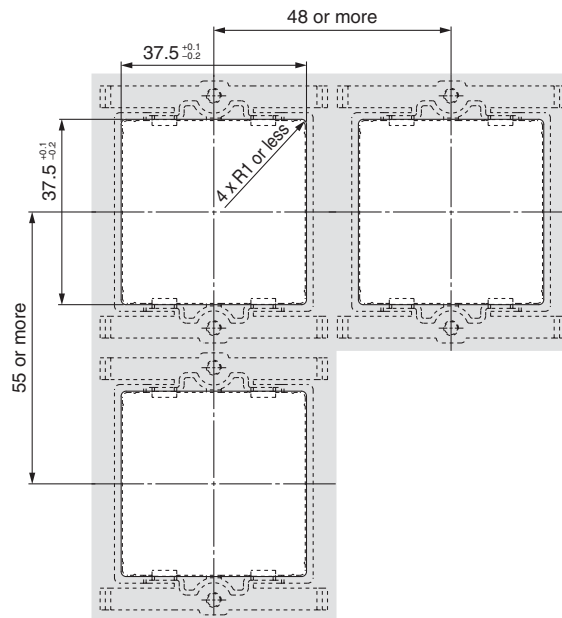

Series LFE

Function Details

Output operation

The output operation can be selected from the following:
Output (hysteresis mode and window comparator mode) corresponding to instantaneous flow rate, output corresponding to accumulated flow, or accumulated pulse output

Note) At the time of shipment from the factory, it is set to hysteresis mode and normal output.

Display color

The display color can be selected for each output condition. The selection of the display color provides visual identification of abnormal values. (The display color depends on OUT1 setting.)

ON: Green, OFF: Red
ON: Red, OFF: Green
Always: Red
Always: Green

Setting of response time

The response time can be selected depending on the application. (1 second for default setting)
The flickering of the display can be reduced by setting the response time slower. If you need faster detection of the problem such as leakage of tip cooling water for welding gun, switch output or analog output can be faster by setting the response time faster. In this case, widen the hysteresis to prevent chattering of the switch output.

Response time	Stability
0.25 seconds	±3.7% F.S.
0.5 seconds	±2.5% F.S.
1 second	±1.7% F.S.
2 seconds	±1.2% F.S.
5 seconds	±0.8% F.S.

Selection of display on sub screen

The display on the sub screen in measuring mode can be set.

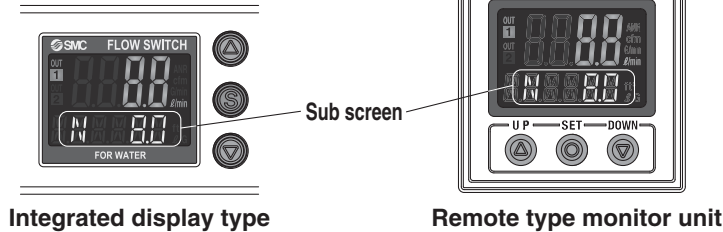

Forced output function

Output is turned ON/OFF compulsorily when starting the system or during maintenance. This enables confirmation of the wiring and prevents system errors due to unexpected output.

For the analog output type, the output will be 5 V or 20 mA for ON and 1 V or 4 mA for OFF.

* Also, the increase or decrease of the flow will not change the on/off status of the output while the forced output function is activated.

Accumulated value hold function

Accumulated value is not cleared even when the power supply is turned off. The accumulated value is memorized every 2 or 5 minutes during measurement, and continues from the last memorized value when the power supply is turned on again.

The life time of the memory element is 1 million access cycles. Take this into consideration before using this function.

Switching of flow direction

Flow direction can be changed after installation.

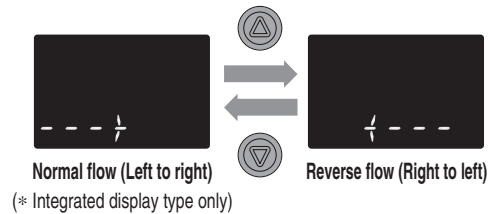

Set value display	Accumulated value display	Peak value display	Bottom value display
Displays the set value. (The set value of OUT2 cannot be displayed.)	Displays the accumulated value. (The accumulated value of OUT2 cannot be displayed.)	Displays the peak value.	Displays the bottom value.
Flow direction display	Line name display	Off	
Displays the flow direction. (* Integrated display type only)	Displays the line name. (Up to 6 alphanumeric characters can be input.)	Displays nothing.	

■ **Selection of power saving mode**

The display can be turned off to reduce the power consumption (Approx.10%). In power saving mode, only decimal points blink. If any button is pressed during power saving mode, the display is recovered for 30 seconds to check the flow etc.

■ **Setting of security code**

Users can select whether a security code must be entered to release key lock. At the time of shipment from the factory, it is set such that the security code is not required.

■ **Peak/Bottom value display**

The maximum (minimum) flow value is detected and updated from when the power supply is turned on. In peak (bottom) value display mode, this maximum (minimum) flow value is displayed.

■ **Keylock function**

Prevents operation errors such as accidentally changing set values.

■ **[F22] Setting of analog output**

This function can be used only when the optional analog output is present. The flow value that generates the output voltage (= 5 V) or output current (= 20 mA) at the span side of analog output can be varied.

<Operation>

Press the or button in function selection mode to display [F22] on the main screen.

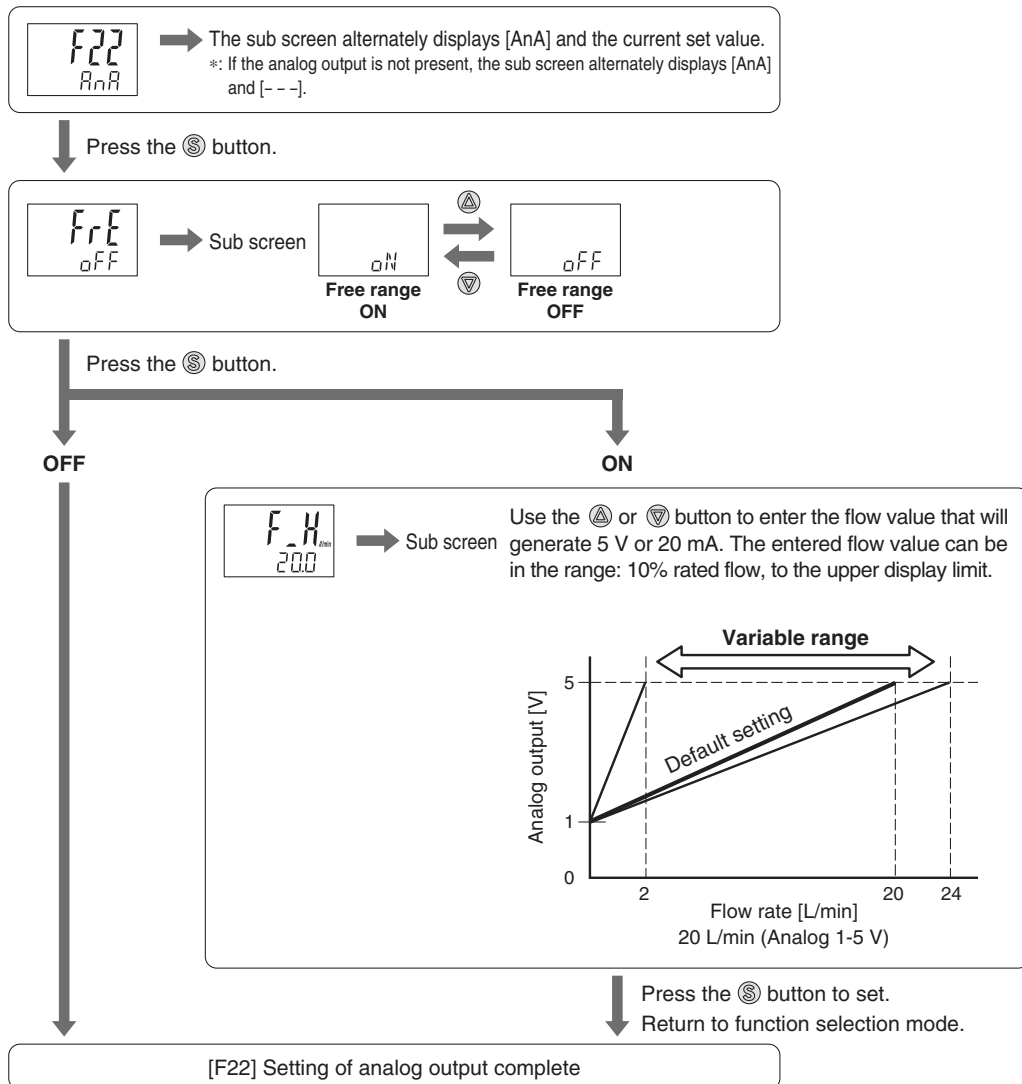

[F22] Setting of analog output complete

Series LFE

■ Error display function

When a failure or abnormality occurs, the location and contents are displayed.

Display	Description	Contents	Action
Er1	OUT1 over current error	Load current of 80 mA or more is applied to the switch output (OUT1).	Eliminate the cause of the over current by turning off the power supply and then turn it on again.
Er2	OUT2 over current error	Load current of 80 mA or more is applied to the switch output (OUT2).	
HHH	Excessive instantaneous flow rate error	Flow has exceeded the display flow range.	Decrease the flow.
LLL	Reverse flow error	Flow is flowing in the reverse direction of the setting.	Change the setting for the flow direction.
9999999999 (alternately displays [999] and [999999])	Excessive accumulated flow error	Flow has exceeded the accumulated flow range.	Clear the accumulated flow. (This error does not matter when the accumulated flow is not used.)
Er0	System error	Displayed if an internal error has occurred.	Turn off the power supply and then turn it on again. If the failure cannot be solved, please contact SMC for investigation.
Er4			
Er6			
Er8			
Er10	Sensor error	Power supply voltage exceeds 24 V \pm 10%.	Check the power supply voltage, and turn off the power supply and then turn it on again.



Series LFE

Specific Product Precautions 1

Be sure to read this before handling. Refer to the back cover for Safety Instructions, "Handling Precautions for SMC Products" (M-E03-3) and Operation Manual for Flow Switch Precautions. Please download it via our website, <http://www.smcworld.com>

Installation

Warning

1. Since the type of fluid varies depending on the product, be sure to verify the specifications.

The switches do not have an explosion proof rating. To prevent a possible fire hazard, do not use with inflammable gases or fluids.

2. Install the system, so that the fluid always fills the detection passage.

If the product is used when the detection passage is not filled, correct detection signal is not output from the electrodes, making correct measurement impossible. Especially for vertical mounting, introduce the fluid from the bottom to the top because bubbles may be generated when applying fluid from the top to the bottom, leading to operation failure.

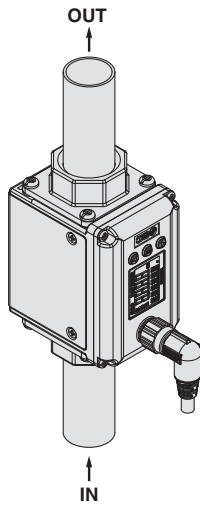

When the product is mounted vertically, place the display vertical to the floor to prevent bubbles from occurring.

Mounting orientation: ○ Mounting orientation: ×

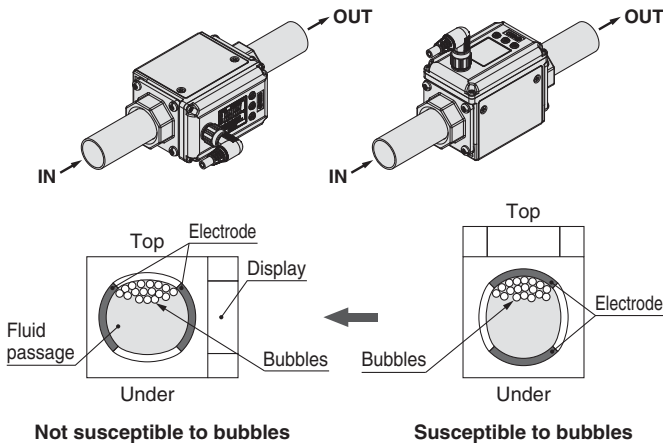

Mounting

Warning

1. Piping port is grounded to DC(-)/blue line.

Do not use the power supply with positive ground.

2. Avoid piping in which the piping size of the IN side of the switch changes suddenly.

If the piping size is reduced sharply or there is a restrictor such as a valve on the IN side, fluid velocity distribution in the piping will be disturbed, leading to improper measurement. Therefore, the above-mentioned piping should be connected on the OUT side.

If the OUT side is opened, or flow rate is excessive, cavitations may be generated, which may result in improper measurement. As a measure against this, it is possible to reduce the cavitations by increasing the fluid pressure. Take action such as mounting an orifice on the OUT side of the switch, and confirm that there is no malfunction before handling. If the orifice of the OUT side is fully closed to operate the pump, the switch may malfunction due to the effect of pulsation (pressure fluctuation). Ensure that there is no malfunction before usage.

3. When multiple sensors are used in parallel, install them outside of the area as shown below. (Uninstallable area) If the product is mounted in the area where installation is prohibited, the accuracy will decrease.

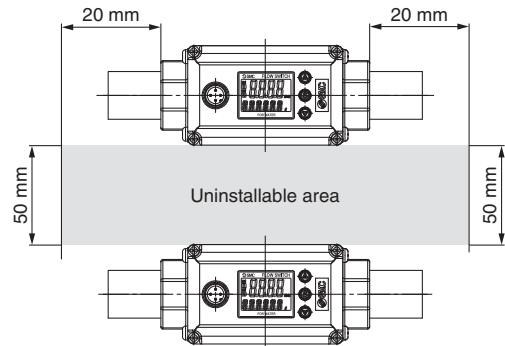

4. Use caution that the electrical entry for lead wire with M12 connector does not rotate and is limited to only one direction.



Series LFE

Specific Product Precautions 2

Be sure to read this before handling. Refer to the back cover for Safety Instructions, "Handling Precautions for SMC Products" (M-E03-3) and Operation Manual for Flow Switch Precautions. Please download it via our website, <http://www.smcworld.com>

Mounting

Caution

- When connecting the piping to the switch, do not rotate the switch. Apply a wrench to the metal part of the piping port to turn the fitting.

Using a wrench on other parts may damage the product. Specifically, make sure that the wrench does not damage the M12 connector. This will damage the connector.

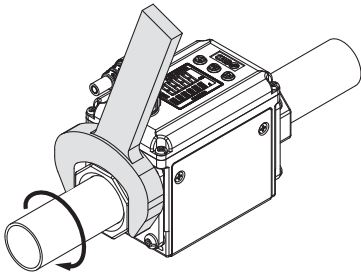

Width across flats of attachment

3/8	24 mm
1/2	28 mm
3/4	35 mm
1	41 mm

Refer to the tightening torque in the right table for connecting steel piping. Torque lower than the value in the table leads to fluid leakage. For mounting the fittings on the market, refer to the torque specified for each.

Nominal thread size	Proper tightening torque (N·m)
Rc (NPT) 3/8	22 to 24
Rc (NPT) 1/2	28 to 30
Rc (NPT) 3/4	28 to 30
Rc (NPT) 1	36 to 38

- The product body is made of resin. Do not impose stress, vibration or impact directly on the product during piping work in order to prevent failure, damage and water leakage.

In particular, never mount a product in a location that will be used as a foothold.

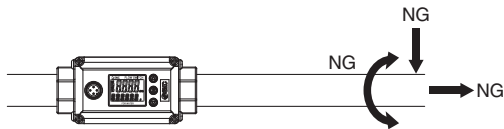

- Secure the front and rear pipes as close to the product as possible in order to prevent stress, vibration and impact from being imposed directly on the product.

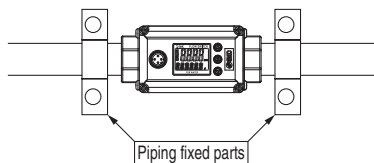

- If stress, vibration and impact imposed on the product cannot be reduced, secure each pipe at multiple positions.

- Inflexible piping such as steel piping tends to be affected by spread of excessive moment load or vibration from the piping side. Lay flexible tubing between the steel pipe and the product to prevent such effects.

In particular, if the piping is off center with the product, load will be imposed on the piping for a long period even after the piping work, possibly resulting in failure, damage or water leakage.

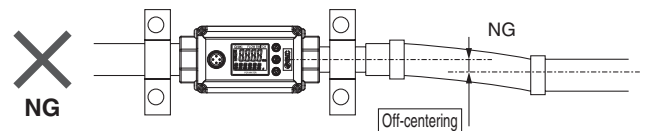
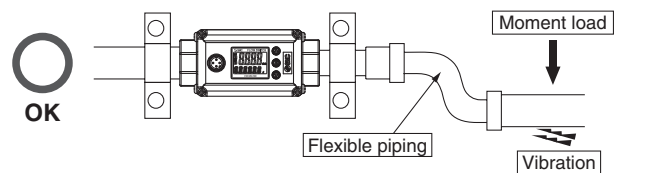

- When using a One-touch fitting, hold the fitting by hand to prevent the load required for connecting or disconnecting the tube from being imposed directly on the product.

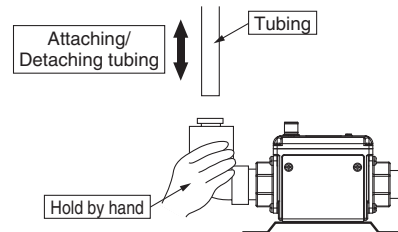

- The straight piping length on the primary side of the product shall be 5 times (5D) or more of the piping size to achieve stable measurement. (Refer to page 4.)
- The operating pressure range and operating temperature range of the product vary depending on the operating conditions. The fluid pressure and temperature should fall within their respective allowable ranges during operation. (Refer to page 4.)



Series LFE

Specific Product Precautions 3

Be sure to read this before handling. Refer to the back cover for Safety Instructions, "Handling Precautions for SMC Products" (M-E03-3) and Operation Manual for Flow Switch Precautions. Please download it via our website, <http://www.smcworld.com>

Operating Precautions

Warning

1. Product temperature becomes high when hot fluid is used. Use caution, as there is a danger of being burned if a valve is touched directly.
2. Enclosure is for this product with lead wire with M12 connector. Be careful when handling the product without connector.

Operating Environment

Warning

1. Never use in the presence of explosive gases.
The switch does not have an explosion proof construction. If it is used in an environment where explosive gases are used, it may cause an explosive disaster. Therefore, never use it in such an environment.
2. Observe the specified fluid and ambient temperature range.
The operating fluid temperature range is 0 to 85°C, and ambient temperature range is 0 to 50°C. Take measures to prevent moisture from freezing in a piping circuit when using at 5°C or less, since this may cause damage to the product and lead to malfunction. Even when the ambient temperature range is within the specifications, do not use in locations where there are rapid temperature changes.
3. If the temperature of the fluid is lower than the ambient temperature, condensation will be generated which may damage the product or cause malfunction.

Maintenance

Warning

1. Take precautions when using the switch for an interlock circuit.
When a pressure switch is used for the interlock circuit, devise a multiple interlock system to prevent trouble or malfunction, and verify the operation of the switch and interlock function on a regular basis.

Fluid

Warning

1. Check regulators and flow adjustment valves before introducing the fluid.
If pressure or flow rate beyond the specified range are applied to the switch, the sensor unit may be damaged.

Fluid

Caution

1. Operate fluids with electric conductivity of 5 μS/cm or more.
Note that this product cannot be used for fluids with low conductivity. This product cannot be used for fluids that do not conduct electricity such as deionized water (pure water) and oil.

Applicable Fluids List

Substance description	Judgement	Note
Water	○	Electric conductivity of tap water: 100 to 200 μS/cm
Deionized water (pure water)	×	Electric conductivity is too low.
Water-soluble coolant	○	When the ratio of water is 50% or more.
Oil	×	Electric conductivity is too low.
Oil-based coolant	×	Electric conductivity is too low.
Sea water	×	Corrosive to the product.
GALDEN®	×	Electric conductivity is too low.
Fluorinert™	×	Electric conductivity is too low.

* Use the applicable fluids list as a guide. ○: Acceptable ×: Not acceptable

The electric conductivity is a ratio which shows how easily the electricity flows.

2. If insulating material gets stuck inside of the piping, it may cause an error.
Remove the foreign material stuck inside of the piping with a brush for washing test tubes so that internal rubber piping will not be damaged.
3. If conductive material such as metal gets stuck to the whole surface in the piping, the switch may malfunction.
Remove the foreign material as mentioned above.
4. If the fluid with stray current running inside is measured, the switch may malfunction.
Beware that earth leakage from the equipment around the switch such as pump and stray current caused by ground fault should not flow into the fluid to be measured.



Series LFE

Specific Product Precautions 4

Be sure to read this before handling. Refer to the back cover for Safety Instructions, "Handling Precautions for SMC Products" (M-E03-3) and Operation Manual for Flow Switch Precautions. Please download it via our website, <http://www.smcworld.com>

Others

Warning

1. After the power is turned on, the switch's output remains off while a message is displayed. (Approx. 3 sec.) Therefore, start the measurement after a value is displayed.
2. Perform settings after stopping control systems.
3. Keep the switch away from the strong magnet and magnetic field to prevent the switch from malfunctioning.

Set Flow Range and Rated Flow Range

Caution

Set the flow rate within the rated flow range.

The set flow range is the range of flow rate that is possible in setting.

The rated flow range is the range of flow rate that satisfies the sensor product specifications (such as accuracy, repeatability).

It is possible to set a value outside of the rated flow range if it is within the set flow range, however, the specification is not be guaranteed.

Sensor	Flow range							
	0.5 L/min	2 L/min	5 L/min	10 L/min	20 L/min	50 L/min	100 L/min	200 L/min
LFE1	0.5 L/min				20 L/min			
	0.4 L/min				24 L/min			
	0.4 L/min				24 L/min			
LFE2		2.5 L/min					100 L/min	
		2 L/min					120 L/min	
		2 L/min					120 L/min	
LFE3			5 L/min					200 L/min
			4 L/min					240 L/min
			4 L/min					240 L/min

Rated flow range
 Display flow range
 Set flow range